

## EXHIBITORS TECHNICAL GUIDE

CIGRE 2026 August 23 > 28, 2026 Palais des Congrès, Paris

[www.cigre-exhibition.com](http://www.cigre-exhibition.com)

### Opening of the Exhibition

on **Sunday 23 August 2026**

from **12:00 pm (noon) to 19:00 pm**

#### After the Opening Ceremony on Sunday

A Welcome Cocktail will be held  
on the Exhibition floor **OPEN TO ALL**  
From around 17:00 to 19:00

#### The Welcome cocktail is **OPEN TO ALL**

*Exhibitors are also welcomed to attend the Opening  
Ceremony meeting at 15:30 pm.*

#### Exhibition opening hours :

<b>Sunday 23 August :</b>	from 12:00 pm to <b>19:00 pm</b>
<b>Monday 24 August :</b>	from 9:00 am to 18:00 pm
<b>Tuesday 25 August :</b>	from 9:00 am to 18:00 pm
<b>Wednesday 26 August :</b>	from 9:00 am to 18:00 pm
<b>Thursday 27 August :</b>	from 9:00 am to 18:00 pm
<b>Friday 28 August :</b>	from 9:00 am to 17:00 pm

Document updated on March 31, 2026 - Informations are subject to change at any time

# CONTACTS

**TECHNICAL EXHIBITION** > [www.cigre-exhibition.com](http://www.cigre-exhibition.com)



David Flandin, General Manager

Wai Ling Chong > [wailing.chong@pro4events.com](mailto:wailing.chong@pro4events.com)  
Deputy Manager

Sandrine Huchez > [sandrine.huchez@pro4events.com](mailto:sandrine.huchez@pro4events.com)  
Sponsorship orders, pack services, web site, mobile app...

Marion Caumont > [marion.caumont@pro4events.com](mailto:marion.caumont@pro4events.com)  
Orders, technics, floor plans, room reservations, badge readers ...

Adil ELHOUMANI > [stand-approval@pro4events.com](mailto:stand-approval@pro4events.com)  
Approval of stand builders constructions

General mail : [info@pro4events.com](mailto:info@pro4events.com)

**CONFERENCE** <https://session.cigre.org>

**GENERAL PROGRAMME** [Session Programme](#)



[PRO4EVENTS for the organization of the CIGRE TECHNICAL EXHIBITION 2026](#)

**Pro4events**  
3-17 chemin du Lanfonnet  
74320 Sevrier - France  
Ph. + 33 (0)1 45 08 97 39  
For the Technical Exhibition:  
[info@pro4events.com](mailto:info@pro4events.com)  
[www.cigre-exhibition.com](http://www.cigre-exhibition.com)

**CIGRE**  
21 rue d'Artois  
75008 Paris - France  
Ph. +33 (0)1 53 89 12 90  
[www.cigre.org](http://www.cigre.org)

Document updated on 28 February, 2026 - Informations are subject to change at any time  
Pro4events, 3-17 chemin du Lanfonnet – 74320 Sevrier – France  
e-mail [info@pro4events.com](mailto:info@pro4events.com) / [www.cigre-exhibition.com](http://www.cigre-exhibition.com)

# CONTENTS

	PAGES
<b>WELCOME TO CIGRE PARIS 2026</b>	
<b>DEADLINES</b>	5
<b>HOTELS</b> cigre-exhibitors.bnetwork.com	6
<b>VENUE</b>	7
<b>GENERAL FLOOR PLAN - SERVICES</b>	8 > 11
<b>OPENING HOURS</b> from Sunday 23 August at 12:00 pm (noon)	12
<b>BADGES FOR EXHIBITORS - Visa letter of Invitation</b>	13, 14
<b>MAIN SOCIAL EVENTS</b>	15
<b>OPPORTUNITIES FOR EXHIBITORS</b>	
<b>SPONSORSHIP OFFERS</b> for Exhibitors only	16
<b>MEETING ROOMS</b> for Rental (Exhibitors only)	17
<b>MANDATORY INFORMATION FOR YOUR STAND BUILDER &amp; STAFF</b>	
<b>STAND LOCATION &amp; DIMENSIONS</b>	18
<b>STAND NUMBER</b> check your stand number	19
<b>STAND FORMULE</b> check your stand formule	20 > 26
<b>BASIC STAND OFFER</b> choose our stand builder for your raw space	20
<b>PILLAR on the Stand</b> > cover the pillars with signage for high visibility	22
<b>UPGRADE TO A PREMIUM STAND</b> with GRAPHICS on walls & desk + storage room	24
<b>CORNER STAND</b>	25
<b>SPRINGBOARD STAND</b>	26
<b>TECHNICAL RULES</b> for your Stand builder	27 > 32
<b>BUILDING &amp; DISMANTLING TIMES</b>	33
<b>TRANSPORT – CUSTOMS – HANDLING</b>	34
<b>DELIVERY OF GOODS</b> Viparis Logipass platform	35, 36
<b>GOODS LIFTS</b>	37
<b>FOR YOUR COMMUNICATION - Tool kit</b>	
<b>EXHIBITORS' PROFILE</b> printed in the Guidebook & displayed on the mobile App <b>Fill in the application form as soon as possible</b> <b>MANDATORY</b> <a href="#">CLICK HERE</a>	
<b>MEDIA KIT</b> signature banner and banner	38
<b>PRESS KITS for journalists</b> in the PRESS CENTER	
<b>JOB OFFERS</b> to be displayed	
<b>BOOK A ROOM</b> (limited to 1 + 1 hours during the week) First come, First served	
<b>OPENING CEREMONY</b> on Sunday 23 August at 15:30 pm - OPEN TO ALL	
<b>NETWORKING</b> A welcome cocktail will be held on the exhibition floor just after the Opening Ceremony OPEN TO ALL	39

## SERVICES TO ORDER FOR YOUR STAND >> Mandatory to order POWER SUPPLY

### Choose to order with the "READY TO EXHIBIT" PACKAGE

ELECTRICITY **mandatory to order** + FURNITURE + 1 TV (if needed)

= 1 SUPPLIER & 1 INVOICE managed by PRO4EVENTS

CUSTOMIZED SERVICE = management of your orders, quick answers to your technical questions & requests, editing of your invoices and personalized feedback by Pro4events

**ELECTRICITY** 41, 42

**FURNITURE**

**TV LED SCREENS** 43

**STORAGE ROOM FOR Formule + (shell) stands**

For premium stands, the storage room is already included 44

## INCREASE VISIBILITY ON THE STAND

**RIGGING STRUCTURES** (suspension points) 45

**COVER THE PILLARS** with advertising material 22

## MORE SERVICES FOR THE STAND

**WIFI** 2.4 Ghz is already included in the Exhibitors' package

For customized or wired internet connections > order on Viparis store 46

### OFFICE EQUIPMENT

Printers, computers, video projectors, electrical equipment> order on Viparis store 47,48

**CLEANING** is already included in the exhibitors' package

= cleaning after the building up + daily cleaning of your stand

**WASTE** removal after building and dismantling > order from Viparis store

**CATERING** 49

**HOSTESS**

**SECURITY GUARDS** 50

**FLORAL DECORATION** 51

**BADGE READER** is already included in the exhibitors' package

= 1 badge reader + 1 license to be downloaded on your smartphone 52

**TECHNICAL ASSISTANCE ON SITE** 53

## GENERAL INFORMATION

**SECURITY & SAFETY** 44

**INSURANCE**

**VAT REFUND** 55

**RECYCLING - REUSE CENTER** for waste reduction 56

**ATTEND THE CONFERENCE** > register on <https://registrations.cigre.org/>

**General Programme** > <https://session.cigre.org/programme/general-programme.html> 57

# DEADLINES

HOTELS	INFORMATION FOR YOUR STAND BUILDER	BADGE REGISTRATION	EXHIBITOR'S COMPANY PROFILE For the guidebook & app	YOUR STAND PROJECT TO BE APPROVED Basic stand or Formula + & Premium if any decoration	GRAPHICS FOR PREMIUM STAND	ORDER SERVICES FOR THE STAND see our "Ready to Exhibit Package"
Book as soon as possible	Send technical information to your stand builder as soon as possible: Technical rules, floor plan...	Exhibitors, Visitors Registrations open in March If you want to attend conferences, register for a Delegate Badge	Register on line your company's profile as soon as possible before 15 April	Send your stand project to our Technical Team before 15 May	Send your graphics to HUBER designer before 15 May	Send your orders to our Team before 15 May <i>It is mandatory to order electricity</i>

SPONSORSHIP Marketing material	INVITATIONS FOR YOUR CLIENTS	RIGGING STRUCTURES	COVER PILLARS	UPGRADE TO A PREMIUM STAND	PACK SERVICES Press, Job Center, Rooms	SPONSORSHIP OFFERS
Send your marketing material to our Team as soon as possible	Send invitations to your clients See our e-banner Free access for Visitors to the Technical Exhibition	Send your order to VIPARIS before 30 May	Send your order to CREATIFS before 30 May	Send your order before 15 June	Send your job offers, room reservations as soon as possible before 30 June	Book our sponsorship offers as soon as possible first come, first served before 15 July

**Paris  
Session 2026**



**Informations are subject to change at any time**  
Pro4events, 3-17 chemin du Lanfonnet – 74320 Sevrier – France  
e-mail [info@pro4events.com](mailto:info@pro4events.com) / [www.cigre-exhibition.com](http://www.cigre-exhibition.com)

# HOTELS

Don't wait to book !

CLICK on [cigre-exhibitors.bnetwork.com](https://cigre-exhibitors.bnetwork.com)

In case you would like to check in before Saturday send a request to bnetwork.

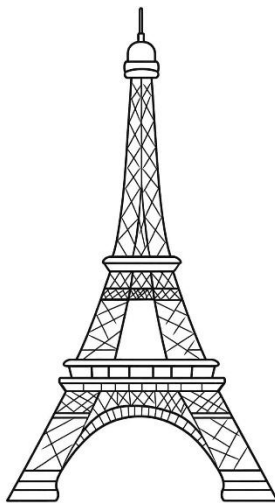

Paris  
Session 2026



Informations are subject to change at any time  
Pro4events, 3-17 chemin du Lanfonnet – 74320 Sevrier – France  
e-mail [info@pro4events.com](mailto:info@pro4events.com) / [www.cigre-exhibition.com](http://www.cigre-exhibition.com)

# Venue : PALAIS DES CONGRES (VIPARIS)

## GOOGLE MAP

2 Place de la Porte Maillot 75017 Paris – France [www.viparis.com](http://www.viparis.com)

ACCESS : <https://www.viparis.com/en/our-venues/palais-des-congres-de-paris-en/access>

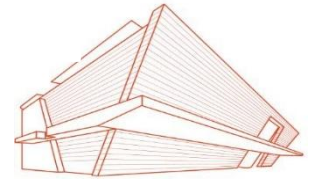
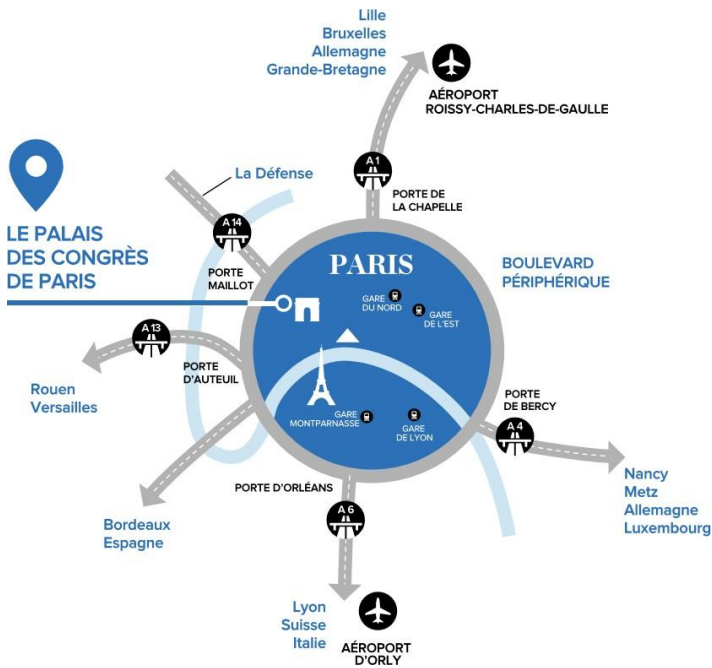

**METRO** Line 1 - Porte Maillot Station – exit 3

**RER C** – Neuilly – Porte Maillot Station

**RER E** – Porte Maillot Station (Gare EOLE in front of the main entrance of the Congress Center) > from or to Gare du nord

**BUS** Lines PC – 82 – 73 – 43 – 244

**TRAMWAY Line T3b** - Porte Maillot Station [CLICK HERE](#)

We invite you to buy your tickets online before your arrival on <https://www.iledefrance-mobilites.fr/en/tickets-fares>

## COMING BY PLANE

**From Roissy-Charles de Gaulle airport** – 30 minutes by taxi

RER B towards Saint-Rémy-lès-Chevreuse to Châtelet – Les Halles, metro line 1 towards La Défense to Porte Maillot

**From Paris-Orly airport** – 45 minutes by taxi

Orlyval to Antony, RER B towards Aéroport Charles de Gaulle to Châtelet – Les Halles, metro line 1 towards La Défense to Porte Maillot

**10% discount** on the Air France or KLM airfare for attendees of CIGRE Session 2026 > [CLICK HERE](#)

Shuttles for the airport Beauvais are on the parking boulevard Pershing (Neuilly side)

## COMING BY CAR

From A1, A4, A6, A10, A15 : Take Paris direction, access via western section of the ring road, exit Porte des Ternes.

From A3, A13, A14 : Take Paris direction, access via southern section of the ring road, exit Porte Maillot.

**PARKING : INDIGO** [www.indigoneo.fr](http://www.indigoneo.fr) Tel. +33 (0)1 40 68 00 11 (the ceiling height is 1.9 m)

## TAXI RESERVATION

At the reception desks Palais des Congrès on level 0 (street level)

Paris  
Session 2026



# GENERAL FLOOR PLAN

Paris  
Session 2026



Floor plans updated on 28 February 2026, subject to changes at any time

## LEVEL 0 street level

Welcome area  
Pick up your badge

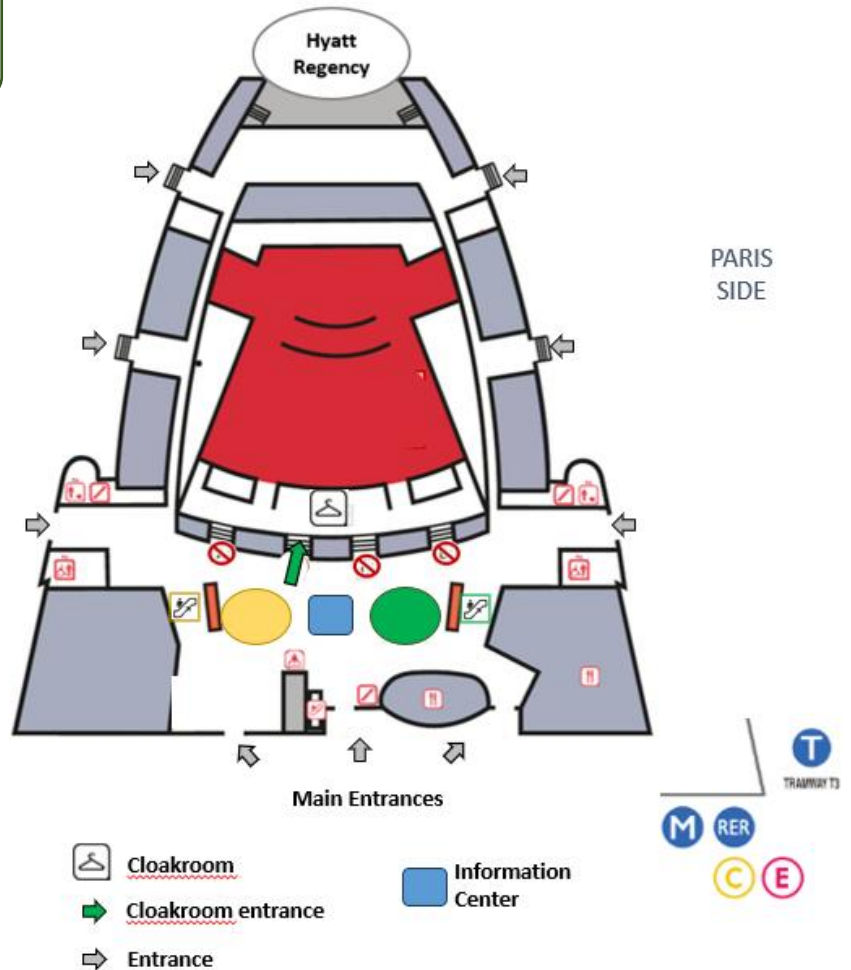

### SESSION CIGRE 2026

Welcome desks on level 0 (open from Saturday 22 August, 9 am) Pick up your badge as soon as you arrive

**TECHNICAL EXHIBITION Levels 1, 2, 3**

**OPEN TO ALL**

#### CONFERENCE

Technical meetings Levels 2, 3, 4

Conference rooms : Amphi Bleu & Grand Amphi, Amphi Maillot (Level 2) – Amphi Havane & Room 352AB (Level 3)

Poster Sessions : Hall Ternes (Level 1)

Tutorials :Amphi Bordeaux (Level 3)







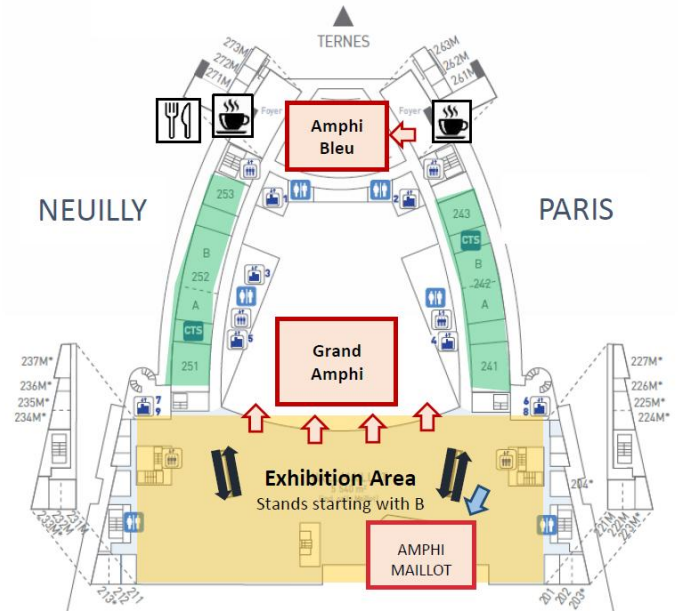
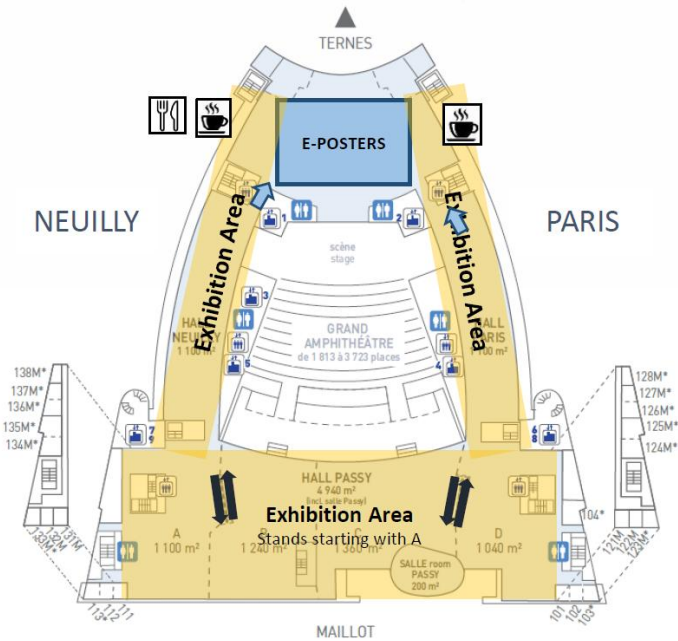

Workshops

**OPEN TO REGISTERED DELEGATES ONLY**

## LEVEL 1

## LEVEL 2



- |  |                       |   |                             |
|--|-----------------------|---|-----------------------------|
|  | E-Posters & Tutorials |  | Main room entrance          |
|  | Conference Rooms      |  | Attendees arrival by stairs |
|  | Exhibition Area       |  | Coffee breaks areas         |
|  | Meeting rooms         |  | Lunch bar                   |

Floor plans updated on 28 February 2026,  
subject to changes at any time

## LEVEL 3

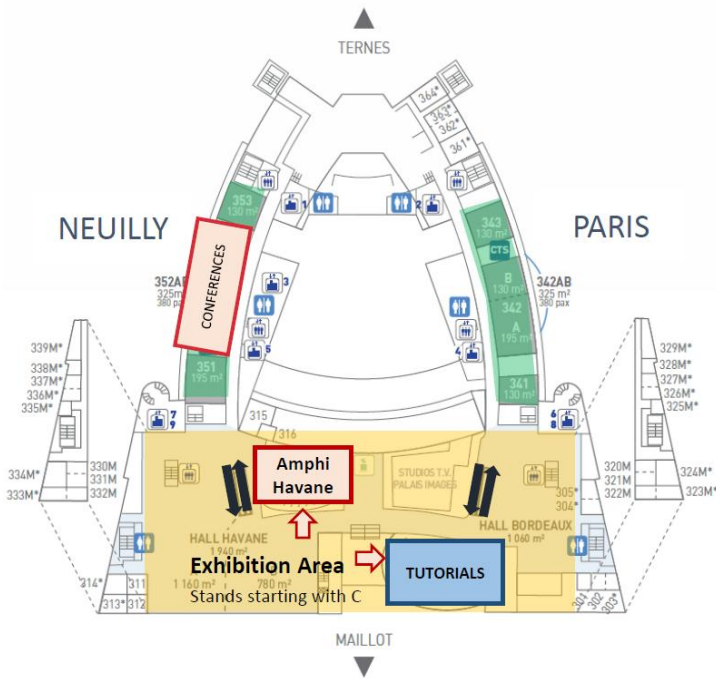

## LEVEL 4

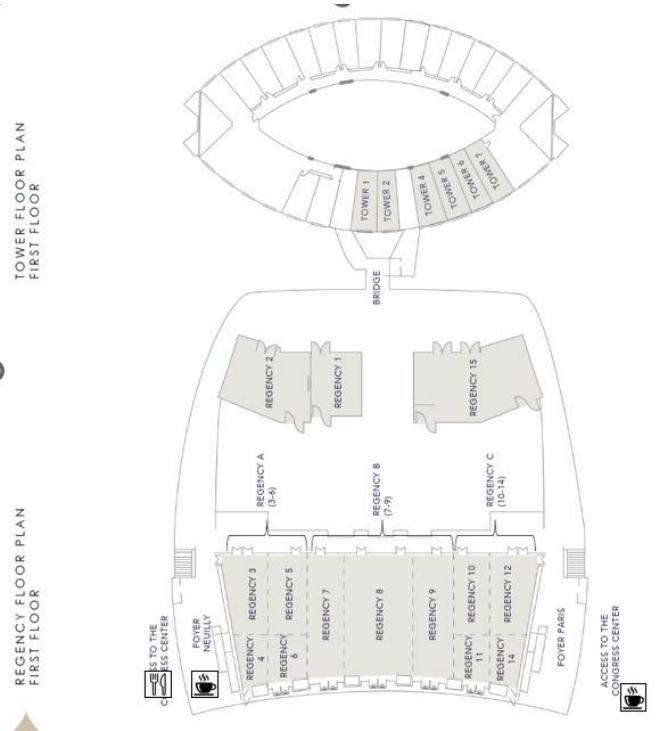

- E-Posters & Tutorials
- Conference Rooms
- Exhibition Area
- Meeting rooms
- ↑
↑
 Main room entrance
- ⇄
 Attendees arrival by stairs
- ☕
 Coffee breaks areas
- 🍴
 Lunch bar

Floor plan updated on 28 February 2026, subject to changes at any time

**List of exhibitors CIGRE 2026 > [CLICK HERE](#)**

After registration, each Exhibition manager receives a mail with the space location booked & dimensions if not received, please contact [marion.caumont@pro4events.com](mailto:marion.caumont@pro4events.com)

Paris  
Session 2026



PRO4EVENTS  
PERFORMANCE FOR YOUR EXHIBITIONS

Pro4events, 3-17 chemin du Lanfonnet – 74320 Sevrier – France  
e-mail [info@pro4events.com](mailto:info@pro4events.com) / [www.cigre-exhibition.com](http://www.cigre-exhibition.com)

# SERVICES

## SERVICES

**Cloakroom** - from Saturday to Friday 7:30 am > 19:00 (closing at 20:30 on Sunday) - Level 0

**Coffee breaks** OPEN to ALL every day (Sunday 14:00 > 15:30) (Monday > Friday 9:30 – 11:00 / 15:00 – 16:30) Levels 1,2,4

**Lunch bars** (snacks, salads) every day from Monday to Friday Levels 1,2,4

**Ice cream bar** every day from 14:30 to 18:00 – Level 4

**Co-working areas / Medical Center** - Level 3 - Room 335

**Free Wifi & cleaning**

**Recycling Center** Level 0 > on the very last day of your visit, you may drop your badges, lanyards, papers

**Multi Faith Prayer** Level 3 – Room 316

*and more to come....*

**TECHNICAL SERVICES for Exhibitors** > Welcome desk to assist exhibitors with supply of power on the stand, delivery of furniture, badge reader pick up, shell stands, premium stands, catering, delivery & handling, ... Orders have to be sent to Pro4events before the event.

**Opening hours :**

**Thursday :** 08:00 > 18:00 / **Friday to Sunday :** 08:00 > 20:00 / **Monday to Thursday :** 08:00 > 18:00 / **Friday :** 08:00 > 17:00

Location on Level 0 (next to the cloakroom) from Thursday 20 to Monday 24 August, 18:00

Location on Level 1 (room 104) from Tuesday 25 to Friday 28 August, 17:00

**REGISTRATION for next exhibitions** Level 3 Room 301 - open from Monday to Friday 9:00 > 18:00

**CIGRE CANADA Calgary 2026 & Toronto 2027 / CIGRE PARIS 2028 / CIGRE 2027 International Symposium in THAILAND**

**EXHIBITORS OFFICE** Level 3 – Rooms 304/305

Keys for exhibitors rooms (pack services)

with a PRESS Center

**JOB Center** Level 1

**CIGRE TV : information, news, interviews to be displayed during the Session**

**Brand Station CIGRE** Level 2 - Room 241

**Publications CIGRE / e-CIGRE** Level 2 - Room 241

**Membership CIGRE** Level 2 - Room 241

**SC/WG welcome office** Level 1 - Room 104

**Session information & lost and found** Information desk Level 0

**SPEAKING AREA** for exhibitors sponsoring the event > “The Experts Forum” on the exhibition floor - Level 3

Just before & during the Session find the updated informations on the mobile App

**Paris  
Session 2026**



Informations are subject to change at any time  
Pro4events, 3-17 chemin du Lanfonnet – 74320 Sevrier – France  
e-mail [info@pro4events.com](mailto:info@pro4events.com) / [www.cigre-exhibition.com](http://www.cigre-exhibition.com)

# OPENING HOURS

Opening of the Technical Exhibition on **SUNDAY 23 August 2026**

At 12:00 pm (noon)

**STANDS MUST BE READY AT 9 am !!** for cleaning service

Exhibition opening hours :

**Sunday 23 August :** from 12 pm to 7 pm  
**Monday 24 August :** from 9 am to 6 pm  
**Tuesday 25 August :** from 9 am to 6 pm  
**Wednesday 26 August :** from 9 am to 6 pm  
**Thursday 27 August :** from 9 am to 6 pm  
**Friday 28 August :** from 9 am to 5 pm

Exhibitors (only) can access 1 hour before the exhibition opening time and stay 30 minutes after the closing time.  
Be aware that it will take longer to access the Session due to the traffic and security checks required at the entrance.

**NEW !** The same day, a **WELCOME COCKTAIL** will be held  
on the 3 levels of the exhibition floor from around 5 pm to 7 pm, just after the Opening Ceremony.

The Welcome cocktail is **OPEN TO ALL !** (Exhibitors, Visitors, Delegates)

Note that Exhibitors are welcomed to attend the Opening Ceremony meeting on Sunday at 3:30 pm  
**Location : Grand Amphithéâtre ACCESS on LEVEL 2**

Paris  
Session 2026



Informations are subject to change at any time  
Pro4events, 3-17 chemin du Lanfonnet – 74320 Sevrier – France  
e-mail [info@pro4events.com](mailto:info@pro4events.com) / [www.cigre-exhibition.com](http://www.cigre-exhibition.com)

# BADGES

Mandatory for professional Visitors, Congress Attendees, Exhibitors, Press...

**Register for your e-badges on line BEFORE the event !**

## EXHIBITORS BADGES (booth staff)

One dedicate link per company. As an exhibitor you have unlimited exhibitor badges and they are complimentary. We kindly request to register only the booth members attending the event. If you have clients or guests coming over to the exhibition area, please indicate the visitors badge registration for them.

If your **Paper** has been selected and you are presenting a session you will need a delegate badge with full access the event.

if not received your dedicated link (one per company) please contact [marianna.castro@pro4events.com](mailto:marianna.castro@pro4events.com)

Reminder : Exhibitors badges give access to the Opening Ceremony & Exhibition ONLY.

**VISITORS BADGES :** Badges for clients, professional visitors who wish to access the Technical Exhibition

### Free badges

Visitors badges give access to the Opening Ceremony, followed by a welcome cocktail, and to the Technical Exhibition, open from Sunday 23 August (starting at 12 pm, noon) to 28 August, 2026.

Each visitor badge is valid during all the event from Sunday to Friday – **at no cost**

**REGISTRATION ON** <https://cigre2026.site.calypso-event.net/en/registration/visitor.htm>

*Each badge is personal (it is not possible to give your badge to another visitor or to exchange it for a Delegate's badge).*

**CONFERENCES :** If you wish to attend the Technical Exhibition and **CONFERENCES**, we invite you to order a **DELEGATE BADGE** directly by registering before the Session on [Paris Session 2026](#)

**Badges are MANDATORY for ALL from Sunday 23 August, 12 pm (noon)**

**No badge required during the building & dismantling times (when the exhibition is closed)**

# VISA REQUEST

The visa letter is integrated on your registration form. For any request regarding this, please make sure you have already registered on the our website.

Are you a CIGRE member ? \*  Yes  No

Visa requirements  Yes  No

VISA - Application for an invitation letter

Birth date \*

Passport : Place

You can download the letter from your registration confirmation email. Any specific request on this, please share your registration number along with your needs to: [marianna.castro@pro4events.com](mailto:marianna.castro@pro4events.com)

Informations are subject to change at any time  
Pro4events, 3-17 chemin du Lanfonnet – 74320 Sevrier – France  
e-mail [info@pro4events.com](mailto:info@pro4events.com) / [www.cigre-exhibition.com](http://www.cigre-exhibition.com)

## WELCOME DESKS TO COLLECT YOUR BADGE

Open from Saturday 22 August, 9 am  
LEVEL 0 (street level)

**COLLECT YOUR PERMANENT BADGE AS SOON AS YOU ARRIVE**  
At the Welcome desks, your e-badges will be exchanged for permanent badges.

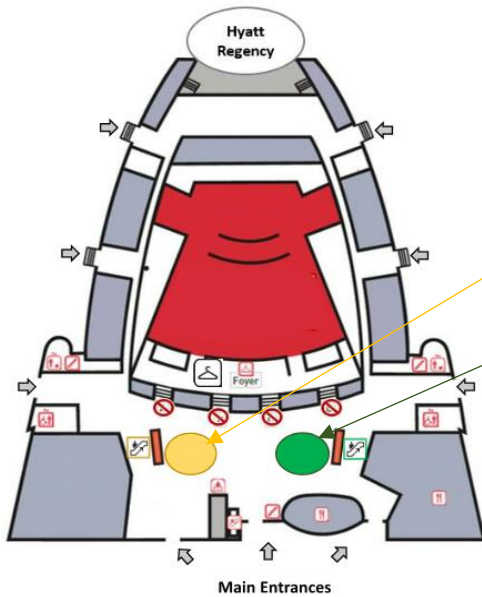

Welcome desks Exhibitors, Visitors, Press  
Welcome desk SC/WG **NEULLY SIDE**

Welcome desks Delegates & Companions **PARIS SIDE**

**Badges must be worn at all times inside the Congress Center from  
Sunday 23 August, 12 pm and during ALL THE EVENT**

**Paris  
Session 2026**



**Informations are subject to change at any time**  
Pro4events, 3-17 chemin du Lanfonnet – 74320 Sevrier – France  
e-mail [info@pro4events.com](mailto:info@pro4events.com) / [www.cigre-exhibition.com](http://www.cigre-exhibition.com)

# MAIN SOCIAL EVENTS

**Sunday 23 August, 2026**

**OPENING CEREMONY** starting at 3:30 pm

Location : Grand Amphithéâtre – Entrance on LEVEL 2

OPEN TO ALL (Delegates, Exhibitors, Visitors)

**WELCOME COCKTAIL** from around 5:00 pm to 7 pm, just after the Opening Ceremony

Location : on the 3 levels of the Exhibition Floor

OPEN TO ALL (Delegates, Exhibitors, Visitors)

**Thursday 27 August, 2026**

**The CIGRE “Soirée” at Paris La Défense Arena** 99, Jardins de l’Arche, 92000 Nanterre – Entrance Gate 33  
From 7 pm to 11.30 pm

Access is strictly limited to the Delegates and their companions (one companion per Delegate)

Participation must be confirmed during the online Delegate registration process

Access will be granted upon presentation of the Delegate badge

More information on [CIGRE Soirée | Session CIGRE](#)

Just before & during the Session find the updated informations on the mobile App

**And much more to NETWORK :**

Coffee breaks each mid-morning and each mid-afternoon

Food & drinks areas

Co-working areas

**Paris  
Session 2026**



Informations are subject to change at any time  
Pro4events, 3-17 chemin du Lanfonnet – 74320 Sevrier – France  
e-mail [info@pro4events.com](mailto:info@pro4events.com) / [www.cigre-exhibition.com](http://www.cigre-exhibition.com)

# SPONSORSHIP OPPORTUNITIES

For registered exhibitors only

TECHNICAL EXHIBITION August 23 > 28, 2026  
Palais des Congrès, Paris

**Become one of the  
exclusive Sponsors !**

[CLICK HERE](#)

Contact : [info@pro4events.com](mailto:info@pro4events.com)

Paris  
Session 2026



## PLUG & WORK AREA

COCKTAIL RECEPTION **SOLD**

NGN EVENT **SOLD**

WiE EVENT **SOLD**

EVENT APP **SOLD**

OUTDOOR BANNERS **SOLD**

ESCALATORS

ESPRESSO BAR **SOLD**

ICE CREAM BAR **SOLD**

SPEECH in the Exhibition

VIDEOS in Conference rooms

VIDEOS in the Congress Center **SOLD**

GUIDEBOOK Advertising pages

INTERVIEW on CIGRE TV

STUDIO with LED WALL for Speeches

HOTEL KEY ROOM **SOLD**

VISUAL BRANDING ON PANELS

## LAST AVAILABILITIES

FIRST COME

FIRST SERVED

## MEETING ROOMS FOR RENTAL

“ready to use” (for exhibitors only)

ALL equipped  
ON THE EXHIBITION FLOOR

Rent a private room to welcome clients, guests during CIGRE Session > First come, First served

OFFER coming in APRIL

CONTACT : [marion.caumont@pro4events.com](mailto:marion.caumont@pro4events.com)

Paris  
Session 2026



Informations are subject to change at any time

Pro4events, 3-17 chemin du Lanfonnet – 74320 Sevrier – France  
e-mail [info@pro4events.com](mailto:info@pro4events.com) / [www.cigre-exhibition.com](http://www.cigre-exhibition.com)

## Stand location & dimensions

After registration, each Exhibition Manager have received a private mail with the location of the stand booked and dimensions. If not received or if any question, please contact : [marion.caumont@pro4events.com](mailto:marion.caumont@pro4events.com)

Please, note :

> the size of a few locations (not all locations are concerned) may change slightly after a last SECURITY CHECK of the floor plan with a difference of + or – 20% as compared to the surface initially booked.

> the position of the pillars is not accurate (+/- 30 cm). Please note that these measurements may vary, so we kindly recommend planning for onsite adjustments if necessary.

You can take advantage of the pillars on the stand to increase visibility > see our post cladding offer

> contact : [info@pro4events.com](mailto:info@pro4events.com)

### ALL STAND PROJECT

or additional building to the shell-stand (Formule + or Premium)  
are to be sent to Pro4events for approval BEFORE May 15, 2026

Send a mail to : [stand-approval@pro4events.com](mailto:stand-approval@pro4events.com) / [adil.regie@gmail.com](mailto:adil.regie@gmail.com)  
[copy to marion.caumont@pro4events.com](mailto:marion.caumont@pro4events.com)

Stand builders must ask the Exhibition Manager to validate the drawings before any submission to Pro4events.

Pro4events hereby reserves the right to modify any stand that fails to comply with the present rules and regulations by any company of its choice and at the sole expense of the exhibitor.

Paris  
Session 2026



Informations are subject to change at any time  
Pro4events, 3-17 chemin du Lanfonnet – 74320 Sevrier – France  
e-mail [info@pro4events.com](mailto:info@pro4events.com) / [www.cigre-exhibition.com](http://www.cigre-exhibition.com)

## BOOTH number

List of exhibitors & stand numbers > [CLICK HERE](#)

Subject to changes

For your communication, be aware that ALL stands have a **Letter** before the stand number.

LEVEL 1 : stand number starts with the letter A

LEVEL 2 : stand number starts with the letter B

LEVEL 3 : stand number starts with the letter C

Contact : [marion.caumont@pro4events.com](mailto:marion.caumont@pro4events.com) / [sandrine.huchez@pro4events.com](mailto:sandrine.huchez@pro4events.com)

### **Exhibition space is the largest ever !**

Demand for stands is much higher for the 2026 edition than in previous Sessions !

### **NEW exhibition spaces**

have been opened to accommodate all the registered exhibitors

**Paris  
Session 2026**



**Informations are subject to change at any time**  
Pro4events, 3-17 chemin du Lanfonnet – 74320 Sevrier – France  
e-mail [info@pro4events.com](mailto:info@pro4events.com) / [www.cigre-exhibition.com](http://www.cigre-exhibition.com)

## Stand formule : Basic / Shell / Premium stand

### BASIC STAND = Raw space

#### Services included in the package :

Raw space

High speed Wifi  
General security

Basic Insurance  
Daily cleaning of your space  
Advertising e-banner for visitors  
Guide book (=catalogue) & mobile app registration

#### + Pack services :

Exhibition staff badges (limited number of free badges)

Badge reader : (1) one electronic badge reader provided for each booth + 1 license to be downloaded on a smartphone.



If you booked RAW SPACE (Basic Stand)  
see one offer from the stand builder

**EVENTS2EVENT**

> <https://events2event.com>

[CLICK HERE](#)

### CUSTOM MADE STANDS

#### Contact :

**Eric DA CRUZ**

Tel : +33 (0)664289644

Email : [edacruz@events2event.com](mailto:edacruz@events2event.com)

COPY to [marion.caumont@pro4events.com](mailto:marion.caumont@pro4events.com)



## SHELL STAND Formule +



Example of stands  
Furniture is not included in the package



Example of a 9 sqm stand  
Non contractual pictures

Stand builder : CREATIFS

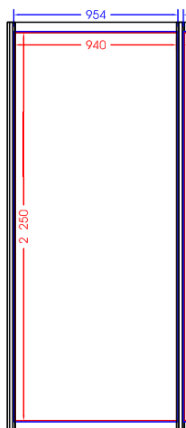

> Inside dimensions of 1 panel  
HT 2250 x L 940 mm

### Services included in the package :

- = Basic stand
- + Partitioning and division walls (grey laminate)
- + Carpet (grey)
- + One sign per open side
- + 3 spotlights on rail / 9 sqm

### OPTIONS for FORMULE + (shell stands) :

#### >STORAGE ROOM

- Storage room 1,00 m x 1,00 m = 223 euros
- Storage room 1,00 m x 2,00 m = 265 euros - closed with a key
- Order form [CLICK HERE](#)



### + Exhibitors have to order power supply for the stand

+ Furniture + (or) TV Led screen(s) *if needed*

Choose our "Ready to Exhibit Package" ALL IN ONE  
managed by Pro4events  
Order form [CLICK HERE](#)

>> **FORMULE + or PREMIUM  
STAND ? [CLICK HERE](#)**

# Pillars on the Stand



Non contractual picture

Use pillars as  
**EYE CATCHERS**  
Cover the pillar on the stand  
with or without signage

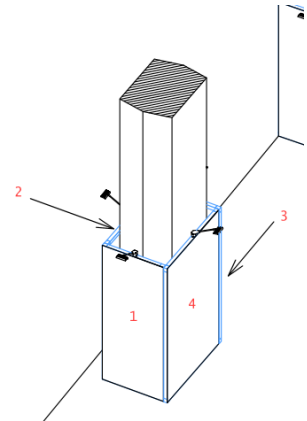

On MELAMINE

## MODULAR PARTITION HEIGHT 2.40M MELAMINE PANEL - ALUMINIUM STRUCTURE

- 122 euros without signage
- 419 euros with signage

Detail of signage :  
PRINTED PVC PANEL TO REPLACE THE PARTITION  
Width 954 mm x Height 2254 mm  
1 unit

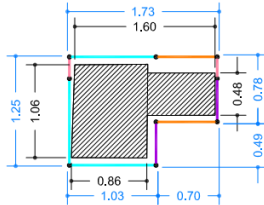

HALL PASSY - level 1

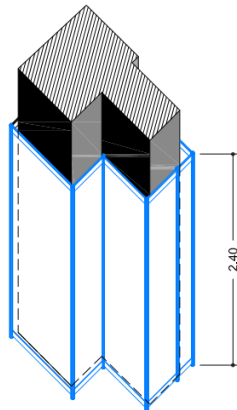

INSTALLATION OF A CURTAIN  
FOR ACCESS TO THE TECHNICAL ELEMENTS  
FOUND ON THE SITE POSTS

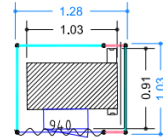

HALL NEUILLY - level 1

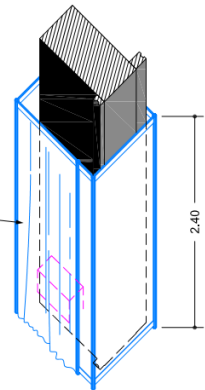

Designed by CREATIFS > send your logo & advertising image to [cigre.exposants@creatifs.fr](mailto:cigre.exposants@creatifs.fr) / copy to [info@pro4events.com](mailto:info@pro4events.com)

## WOOD PARTITION HEIGHT 2.50M WOOD PARTITION THICKNESS 60mm COVERED IN COTTON

- 279 euros without signage
- 575 euros with signage

Detail of signage :  
PRINTED PVC PANEL FIXED AGAINST PARTITION  
Width 1000 mm x Height 2500 mm  
1 unit

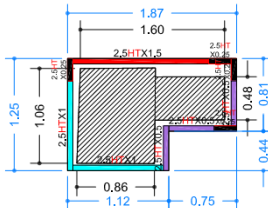

HALL PASSY - level 1

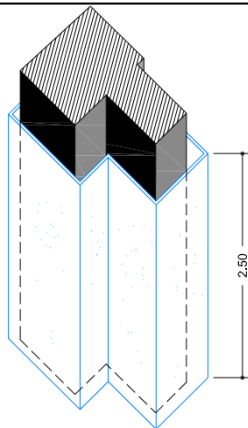

INSTALLATION OF A CURTAIN  
FOR ACCESS TO THE TECHNICAL ELEMENTS  
FOUND ON THE SITE POSTS

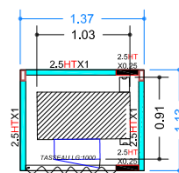

HALL NEUILLY - level 1



Order form [CLICK HERE](#) / contact : [marion.caumont@pro4events.com](mailto:marion.caumont@pro4events.com)

# PREMIUM STAND

Personalize your stand at your image

**Stand builder : HUBER MESSEBAU**  
 contact : Diego Alemanni  
 d.alemanni@huber-messebau.ch



Non contractual pictures



Example of premium stands

This stand image is only an example. Your stand could have a completely different shape

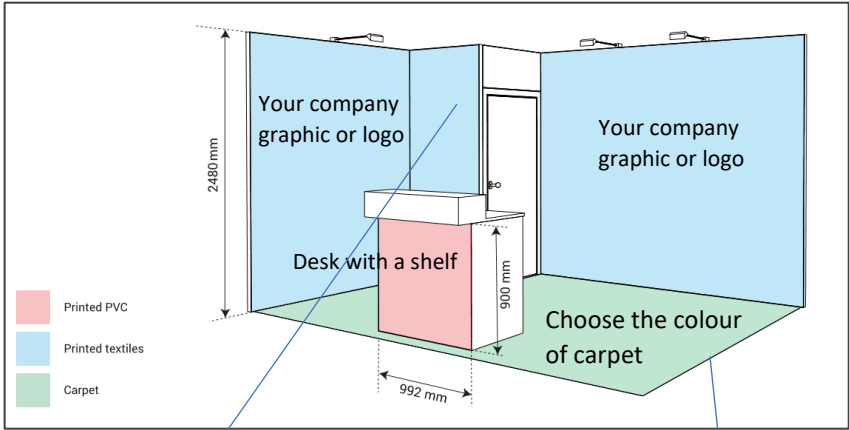

**Options for PREMIUM stands :**  
 > 3 shelves & Wardrobe = 64 euros  
 Order form [CLICK HERE](#)

- Services included in the package :**
- = Basic stand
  - + Personalized choice of colors for walls (textile) and carpet
  - + 1 welcome desk with a shelf
  - + Logos and company graphics on the welcome desk and on the walls
  - + Storage room (1 sqm up to 15 sqm – 2 sqm for larger stand) with key
  - + 1 spotlight LED 30W / 3 sqm

**HOW TO PREPARE GRAPHIC FILES**  
 > [CLICK HERE](#)

Graphic designer : cad@huber-messebau.ch

**+ Exhibitors have to order power supply for the stand**

+ Furniture + (or) TV Led screen(s) if needed

Choose our "Ready to Exhibit Package" ALL IN ONE managed by Pro4events  
 Order form [CLICK HERE](#)

**Shell > premium stand      Basic > premium stand**  
**> upgrade TO a premium stand**

**SHELL STAND**

OR



**PREMIUM STAND**

Personalize your stand at your image

What is included = Basic stand package

+

**Walls in grey laminate**

**Carpet in grey**

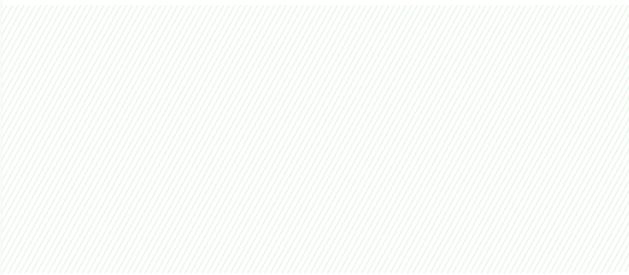

3 spotlights on rail / 9 sqm

+ One sign per open side & a floor marker with your stand number

**Walls with your company graphics / logo**  
printed on textile

**Carpet** > choose among 9 colours



**+ A welcome desk with a shelf**  
with your graphics / logo printed on pvc



**+ A storage room** closed with a key  
1 sqm for a stand up to 15 sqm – 2 sqm for a larger stand

spotlights LED 30W > 1 spotlight / 3 sqm

+ A floor marker with your stand number

If your company ordered a BASIC STAND (raw space) & is registered as a CIGRE Member,  
upgrade for **520 euros / sq.m.**

If your company ordered a FORMULE + Shell stand & is registered as a CIGRE Member,  
upgrade for **315 euros / sq.m.**

To upgrade, **Complete the order form HERE**

+ send a mail to [info@pro4events.com](mailto:info@pro4events.com) / [marion.caumont@pro4events.com](mailto:marion.caumont@pro4events.com)

**Deadline 15 June, 2026**

**Paris  
Session 2026**



## CORNER BOOTH PREMIUM on Level 2

Stand builder : **HUBER MESSEBAU**  
contact : Diego Alemanni  
d.alemanni@huber-messebau.ch



in a **high-traffic area**, next to the Posters area and meeting rooms for rental

**Facing the popular coffee breaks** (2 × 1h30 per day, free for all attendee)

**Access to a shared meeting area : MEETING PAVILION** not far from the booths, enabling exhibitors to meet and discuss with clients with convenience

### Stand 6 sqm / Back wall 2 m high

does not include the high chair, power supply or any furniture and electronics.

Welcome desks, Chairs and TVs... are available for rental

**Non contractual pictures**

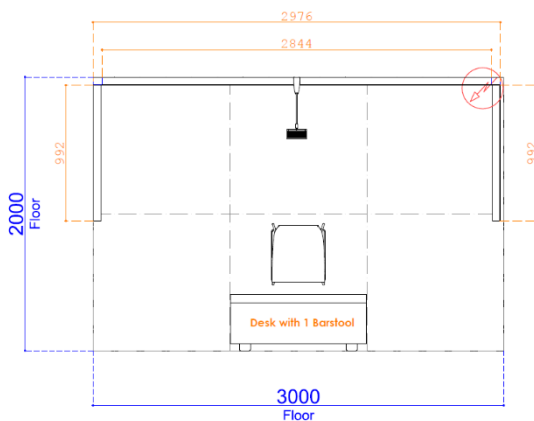

**After registration and approval from Pro4events,**  
**Send your Graphics to HUBER MESSEBAU**

Services included in the package :

- = Basic stand (including pack services, 1 badge reader)
- + Personalized choice of colors for the back wall (textile) and carpet
- + 1 welcome desk
- + Logos and company graphics on the welcome desk and on the back wall
- + 1 spotlight LED 30W

+

Exhibitors have to order power supply for the stand

+ Furniture + (or) TV Led screen(s) if needed

Choose our "Ready to Exhibit Package" ALL IN ONE managed by Pro4events

Order form Order [CLICK HERE](#)

### HOW TO PREPARE GRAPHIC FILES

> [CLICK HERE](#)

Graphic designer : cad@huber-messebau.ch

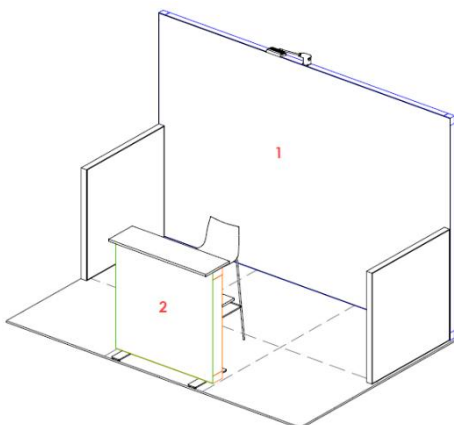

**Paris  
Session 2026**



For any information (space is very limited),  
please contact [wailing.chong@pro4events.com](mailto:wailing.chong@pro4events.com) / [marion.caumont@pro4events.com](mailto:marion.caumont@pro4events.com)

## SPRING BOARD BOOTH



Spring Board Stand  
Non contractual picture

= SHELL STAND

SHARED with 2 or 3 other Springboarders  
[CLICK HERE to see the Package](#)

After registration and approval from Pro4events,  
Send your logo JPEG format + in High Resolution

If you want to give a speech in the Exhibition, ask for a speech slot  
(wait for the confirmation from Pro4events)

First come, first served.

+ You may want to bring your own roll-up to display against the wall

[To sandrine.huchez@pro4events.com](mailto:sandrine.huchez@pro4events.com)

### Limited space & availabilities

#### Conditions to Apply:

- ✓ NEVER Exhibited at Any CIGRE Event Before
  - ✓ With Less Than 20 Employees
- ✓ Aimed at Marketing a Scalable, Innovative, Technology-Enabled Product / Service in the Field of CIGRE Activities
  - ✓ Comply With the Exhibitor's Rules on <https://www.cigre-exhibition.com/form/cgv>
  - ✓ Only Small Devices & Products for display

Your registration is confirmed only after you get approval from Pro4events

Paris  
Session 2026



Updated on 30 January, 2026

Sunday 23 August > Friday 28 August, 2026  
VENUE : Palais des Congrès, Porte Maillot, Paris (VIPARIS)

## Please, transfer the following technical regulations to your stand contractor

### GENERAL INFORMATION

Safety rules regarding risks of fire and panic in establishments open to the public have been established by the Order dated June 25<sup>th</sup>, 1980 (general provisions). The Order dated November 18<sup>th</sup>, 1987, sets forth the specific provisions applicable to exhibition halls. The text below is excerpted from said regulations in order to facilitate understanding.

The Safety board is quite severe regarding stand construction (stability, construction and decoration materials, electrical installations, etc...). The decisions made during safety board inspections, the day before of the morning the event opens must be immediately implemented. Stand installation must be completed for Safety board inspections.

The Exhibitor (or his representative) must be present at the stand and be prepared to provide flammability reports for all materials used. Non-compliance with this rule may lead to the removal of such materials or a prohibition on opening the stand to the public. All large projects (Basic stands = construction on raw space) must be submitted to the trade show's safety Supervision for approval.

### A. STAND CONSTRUCTION RULES

**Stand drawings :** After registration, each Exhibition Manager will receive a private mail from the organiser Pro4events with the space and dimensions of the location booked > for any question, contact : [marion.caumont@pro4events.com](mailto:marion.caumont@pro4events.com)

Please, note :

> the size of a few locations (not all locations are concerned) may change slightly after a last SECURITY CHECK of the floor plan with a difference of + or – 20% as compared to the surface initially booked.

> the position of the pillars is not accurate (+/- 30 cm)

You can take advantage of the pillars on the stand to increase visibility > see our post cladding offer

> contact : [marion.caumont@pro4events.com](mailto:marion.caumont@pro4events.com)

#### **ALL STAND PROJECT**

or additional building to the shell-stand (formule plus or premium)

**are to be sent to the organiser Pro4events for approval BEFORE 15 April, 2026**

Send a mail to : [stand-approval@pro4events.com](mailto:stand-approval@pro4events.com) / Adil EL HOUMANI <[adil.regie@gmail.com](mailto:adil.regie@gmail.com)>

[copy to marion.caumont@pro4events.com](mailto:marion.caumont@pro4events.com)

Stand builders must ask the Exhibition Manager

#### **Height of booth construction & signs :**

The maximum height authorised for any construction in alignment with the gangways and next stands is fixed at **2.50 m** (platform included).

The maximum height for signs and construction is **3.00 m** with a distance of 1.00 m back from the next stands and from the gangways. Exemptions for signs may be granted on request.

There are different heights in the hall > please check on the floor plan and contact the organiser Pro4events for a **FINAL APPROVAL**  
> [marion.caumont@pro4events.com](mailto:marion.caumont@pro4events.com) & [stand-approval@pro4events.com](mailto:stand-approval@pro4events.com) / Adil EL HOUMANI <[adil.regie@gmail.com](mailto:adil.regie@gmail.com)>

**Suspension from the framework** : The Palais des Congrès (VIPARIS) is the ONLY company allowed to install slings > [CLICK HERE for more information](#)

**Partition walls** : no more than 50 % of the total length along the gangways.

**Platform or raised floor** : in case exhibitors want to raise the floor, an access ramp is required.

**Signs** : illuminated signs are allowed. In no case, they may be intermittent or flashing. White letters on a green background are forbidden.

**Noise level** : the maximum allowed level of noise for advertising is 75 dB (at one meter from the ground).

**Maximum load** : Any exhibitor displaying elements or structures built with a total weight of more than 500 kg must send to the organizer ([marion.caumont@pro4events.com](mailto:marion.caumont@pro4events.com) & [stand-approval@pro4events.com](mailto:stand-approval@pro4events.com)), at the latest 3 months before the exhibition, a file of presentation with a certificate certifying that the distribution of the load on the ground of the together is less than 500 kg / square meter. During assembly and in case of doubt the intervention of an approved controller will be required and the following costs billed to the exhibitor.

**Overhead coverings** (ceiling, false ceiling, solid canopy) and awnings are allowed with restrictions & limitations and ONLY if authorised by the organiser and the venue

> you have to submit your project to [marion.caumont@pro4events.com](mailto:marion.caumont@pro4events.com) & [stand-approval@pro4events.com](mailto:stand-approval@pro4events.com) / for advise and final agreement.

### What is prohibited :

- Elevated floor stands (raised floor is allowed)
- Borings into the ground
- Curtains, drapes and net curtains in front of exits,
- Paint and varnish classified as inflammable (nitrocellulose or glycerophthalic for example),
- Use of sign or advertisement panels in white letters on a green background,
- stands with more than 1 level
- Closed stands or rooms (in case, you have an exceptional authorization from the organiser, you have to submit your project to [marion.caumont@pro4events.com](mailto:marion.caumont@pro4events.com) & [stand-approval@pro4events.com](mailto:stand-approval@pro4events.com) for final agreement).

### Number and width of exits :

If S is < 19 sq.m: 1 of 0.90m

20 sq.m ≤ S < 50 sq.m: 1 x 0,90m and 1 x 0,60m

50 sq.m ≤ S < 100 sq.m: 2 x 0,90m or 1 de 1,40m and 1 x 0,60m

100 sq.m ≤ S < 200 sq.m: 1 x 1,40m and 1 x 0,90m or 3 x 0,90m

200 sq.m ≤ S < 300 sq.m: 2 x 1,40m

S > 300 sq.m, Exits should be carefully positioned and marked (S = surface)

If any question, please contact HERVE PIERRE SAS / Mr. Charles JARDINIER / 2 rue Maurice UTRILLO / 95110 SANNOIS /

e-mail : [anthony@hervepierre.com](mailto:anthony@hervepierre.com).

### Accessibility for persons of reduced mobility (PRM)

The Exhibitor must comply with French regulations and with the accessibility order. These regulations specify that all premises and facilities open to the public must allow access to the disabled and to people with reduced mobility. This means that one or several ramps, of a minimum width of 90 cm, will facilitate access. Slopes will respect the following percentages:

- 4 % slope without limit to the length of the passageway
- 5 % slope on a length of less than 10m
- 8 % slope on a length of less than 2m
- 10 % slope on a length of less than 0.5m
- 33% slope for a threshold of 4 cm (ie a depth of 12 cm for a floor height 4 cm)

Clearance of a radius of 1.5 m will be left free for manoeuvring at each end of the ramp.

Welcome and information desks must be accessible to people using a wheelchair: height 80 cm, a gap of 30 cm depth on a height of 70 cm, enabling space for knees.

Width of 1.4 m minimum for pathways.

Ramps with minimum width of 90 cm are requested.

PRO4EVENTS reserves the right to have any stand, not respecting the General Regulations, modified by a company of his choice, and at the Exhibitor's own expense.

## **B. FIRE SAFETY RULES**

Fire and panic risk prevention regulations establishments frequented by the public are specified in the Ministerial Order dated 25 June 1980 (general provision). The ministerial Order dated 18 November 1987 stipulates the special measures applicable to exhibition halls. The text below is composed of extracts from these regulations in order to facilitate comprehension.

Any information concerning fire safety can be obtained before the Event from: **HERVE PIERRE SAS / Mr. Charles JARDINIER / 2 rue Maurice UTRILLO / 95110 SANNONIS / e-mail : anthony@hervepierre.com**

During the setting-up period, Mr Anthony Landais will ensure that all security measures indicated here are applied.

### **Materials :**

The materials used must comply with fire reaction characteristics. They are classified into 5 categories M0, M1, M2, M3, and M4 (M0 corresponds to an incombustible material).

### **Requirements :**

- Stand framework and partitions classified **M3** as a minimum,
- Large pieces of furniture (boxes, counters, presentation cases, screening, etc.) classified **M3** as a minimum,
- Wall coverings (natural or plastic fabrics) classified **M2** as a minimum (they may be stretched or fixed with staples; Sundry finishes (fabrics, paper, plastic film) which are very thin (1 mm maximum) may be used when fixed in a full bed of adhesive to backgrounds of M0, M1 M2 or M3 materials. Embossed or textured paper, however, must be fixed in a full bed of adhesive onto M0 materials only),
- Materials on display : Materials on display may be shown on the stands without any requirements for fire resistance. However, if those materials are used for decorating the partitions of false ceilings, and if they represent more than 20 % of the total area of these elements, the requirements in the above paragraphs shall be applicable to them,
- Floral decoration : Limited use should be made of floral decorations in synthetic materials. If this is not the case, these decorations must be made from **M2** materials,
- Curtains, drapes and loose net curtains classified **M2** as a minimum (They are forbidden on entrances and exits to the stands, but permitted on doors to internal rooms),
- Paints & varnishes : strictly forbidden if they are deemed to be inflammable (based on nitro-cellulose or alkyds for example),
- Floor covering must be firmly fixed, classified **M4** as a minimum,
- Covering for podium, platforms or tiered seating (if > 0,30 m and if S> 20 sq.m.) classified **M3** as a minimum (h = height, S = surface),
- Floating decorative elements or trims (advertisement panel if S > 0,50 sq.m., garlands, light decorative objects, etc.), classified **M1** as a minimum (the use of signs or advertising panels using white letters on a green background is strictly forbidden, as the colours are reserved exclusively for indicating exits and emergency exits),
- Canopies, if building fitted with sprinklers, classified **M2** as a minimum, otherwise **M1**, CNPP-approved mesh canopies. (CNPP – French Test Laboratory).

### **Equivalences for wood :**

- Non-resinous solid wood : if thickness  $\geq 14$  mm, classified **M3**,
- Resinous solid wood : if thickness  $\geq 18$  mm, classified **M3**,
- Panels made from wood derivatives (plywood, boards, wood fibres, chipboard) : if thickness  $\geq 18$  mm, must be classified **M3**.

## Fire classification

Classes selon NF EN 13501-1 (hors sol)				classes selon NF EN 13501-1 (hors sol)			
A1	-	-	Incombustible	C	s1		M2
A2	s1	d0	M0		s2	d0	
A2	s1	d1	M1		s3	d1	
A2	s2	d0	M1	D	s1		M3
	s3	d1			s2	d0	M4
					s3	d1	non goutant
B	s1			E-d2 à F			M4
	s2	d0		SOL			
	s3	d1					
C	s1		M2	Bfl	s1		M4
	s2	d0			s2		
	s3	d1					

## Fire certificates

At any time, the Security Manager may request exhibitors the official report giving the fire classification of materials used in stand construction or failing this, the equivalent fireproofing certificates. All coatings, coverings and material meeting the requirements of security are sold in specialized shops, where the quality certificates as regards the classification of fire resistance may be obtained from the :  
Groupement NON FEU / 37-39, rue de Neuilly BP 121 / 92113 Clichy Cedex / Tel. 01 47 56 30 80

## Fireproofing certificates

By means of different procedures or applications, any material which normally would be of medium or high flammability, may obtain the flame resisting qualification of M2. These procedures would be: inflammable liquid spraying, brush application of a paint or special varnish or immersion in a special bath solution. These operations of fireproofing may be performed by an officially qualified person or contracting company who may issue a homologated certificate giving the following specifications. The exact names, addresses and telephones may be obtained from the :

Groupement Technique Français de l'ignifugation / 10, rue du Débarcadère / 75852 Paris cedex 17 / Tel. 01 40 55 13 13  
Reports of foreign origin cannot be taken into consideration. Only reports issued by approved French laboratories can be accepted.

## Exhibitors obligations

Exhibitors must keep on their stands the official report giving the fire classification of materials used in stand construction, (failing this, the equivalent fireproofing certificates).

It shall be strictly forbidden to set any type of fitting out whatsoever over the aisles (structure of signboards, walkway, etc).

## C. POWER SUPPLY & ELECTRICAL INSTALLATION

Exhibitors need to order power supply for the stand > choose to order the "Ready to Exhibit package" (Electricity + Furniture + (or) TV Led screens) = 1 supplier / 1 invoice, all in one & customized service managed by Pro4events ([order form click here](#)) > contact [marion.caumont@pro4events.com](mailto:marion.caumont@pro4events.com) or order on VIPARIS Store <https://www.viparisstore.com/en/cigre-2026>

### Electrical installation (by VIPARIS) :

- Electrical connections must be made inside connecting boxes,
- The electrical cut-off devices must be permanently accessible to the staff on the stand,
- The installations must only have fixed wiring systems,
- Cables and conductors must be category C2,
- Ducts and rails used to route cable, and cable covers must be flame-resistant, in compliance with the current standards,
- All wiring systems must have a protection conductor connected to the earth terminal on the electricity supply panel,
- If class 0 materials exhibited are powered up, they must be protected by residual current mechanisms set a maximum of 30 mA,
- Class 1 appliances must be connected to the protective conductor of the wiring system supplying the power,
- the use of individual protected earth sockets is prohibited.

Electricity junction boxes and supply panel cupboards: These must be in a metal casing, inaccessible to the public, easily by staff and fires services, sited away from all flammable and combustible materials and products.

### IMPORTANT : if the power supply is more than 100 kVA

- The supply panel must be in a cupboard dedicated solely to this use,
  - The location must be signed,
  - A CO2 or powder extinguisher must be adjacent,
  - Partitions must be classified M3,
  - The supply panel must not located under a mezzanine floor accessible to the public,
- A declaration is required if the power supply exceeds 100 kVA.

### **Halogen lamps (EN 60598 standard)** Halogen stand lighting must :

- be fixed at a minimum height of 2,25 m,
- be kept away from any flammable materials (at least in 0,50 metres from wood and other decorative materials),
- be firmly fixed,
- be fitted with a safety screen (glass or fine mesh grill) to provide protection from a possible explosion of the lamp.

### **High-voltage illuminated signs** These must :

- be protected by a screen made of a material in class M3 at least. The switch to turn them off shall be indicated and the transformers shall be placed in a position that cannot cause any danger,
- have a clearly-labelled "off" switch,
- have transformers out of people's reach,
- have "danger, high voltage" notices as required.

### **PROHIBITED EQUIPMENT, PRODUCT, GASES :**

- Multiple sockets and adaptors are prohibited. Only connecting boxes shall be permitted,
- The distribution of samples or products containing an inflammable gas,
- Balloons inflated with a flammable or toxic gas,
- Articles made of celluloid,
- The presence of pyrotechnic or explosives devices,
- The presence of ethyl oxide, carbon sulphide, sulphuric ether and acetone,
- The use of acetylene, oxygen, hydrogen or equivalent high-risk gases. Note: a request for dispensation can be submitted to the French administration,
- Pyrotechnic effects, devices producing detonations, sparks or flames,
- Use of flammable liquids is prohibited inside the Venue VIPARIS but for exceptional use, ONLY after authorisation, it must be limited to the following quantities per stand : 10 litres of flammable liquids of 2nd category for 10 m<sup>2</sup> of stand, with a maximum of 80 litres, 5 litres of flammable liquids of 1st category.

### **EMERGENCY RESSOURCES**

- These must remain permanently visible and reachable
- If there is a fire hose point (RIA) on the stand, a one-meter wide passage from the aisle must be provided to give permanent access. Signs must be visible.

### **OPERATING INSTRUCTIONS**

- It is prohibited to deposit boxes or stock cases, wood, straw, cardboard, etc... in the Exhibition halls, on the stands or in the aisles. Emergency equipment must remain visible at all times. Daily cleaning is necessary to clear the premises of rubbish of all kinds.

## **D. SANITARY MEASURES**

The venue, VIPARIS, has been accredited with the label « **Safe V Events** » from an independent authority.

All the necessary health measures are taken to ensure the highest standards during the Session :

- > **Disinfection** of rooms, common areas, surfaces, equipment, lifts at all times, hand sanitiser available, air recycling,
- > **Medical Center** with dedicated medical staff on level 3 (room 335).

## **E. SECURITY**

To ensure your safety during your stay at the venue VIPARIS, we have increased the number of agents during the Session, in addition to webcams. **BE AWARE that it will take longer to access the Session. Security check is required before entering the Congress Center.**

Please be reminded that the venue is a NON-SMOKING building. The consumption of alcohol is strictly forbidden and during the set up and dismantling of events.

## F. DELIVERY OF GOODS

The venue, VIPARIS, is requesting registration of vehicles prior to the delivery on <https://logipass.viparis.com/en>

THE OFFICIAL TRANSPORT COMPANY IS DB SCHENKER [www.dbschenker.com/fr](http://www.dbschenker.com/fr)

Contact : Meriam SAGET : [meriam.saget@dsv.com](mailto:meriam.saget@dsv.com); [foires.expositions@dbschenker.com](mailto:foires.expositions@dbschenker.com)

**Telephone number: +33 (0)1 48 63 31 82**

It is prohibited to deposit boxes or stock cases, wood, straw, cardboard, etc... in the Exhibition halls, on the stands or in the aisles. Emergency equipment must remain visible at all times.

Exhibitors can be invoiced by VIPARIS for waste removal > Viparis store <https://www.viparisstore.com/en/cigre-2026-for-power-system-expertise>

+

### **IMPORTANT SPECIFIC SAFETY RULES for your stand builder**

#### **Make sure to read the following documents**

HERVE PIERRE SAS / Mr. Charles JARDINIER / 2 rue Maurice UTRILLO / 95110 SANNOIS /  
e-mail : [anthony@hervepierre.com](mailto:anthony@hervepierre.com)

>>>> **ENGLISH VERSION** > <https://www.cigre-exhibition.com/wp-content/uploads/sites/1/SPECIFIC-SAFETY-RULES.pdf>

>>>> **FRENCH VERSION** > <https://www.cigre-exhibition.com/wp-content/uploads/sites/1/REGLES-SPECIFIQUES.pdf>

**Contact : [info@pro4events.com](mailto:info@pro4events.com)**

Pro4events hereby reserves the right to modify any stand that fails to comply with the present rules and general conditions by any company of its choice and at the sole expense of the exhibitor.

> see the General Conditions on : [CIGRE 2026 GENERAL RULES \(www.cigre-exhibition.com/form/cgv/\)](http://www.cigre-exhibition.com/form/cgv/)

This document has been updated on 28 February, 2026 and is subject to changes at any time

**PRO4EVENTS**  
PERFORMANCE FOR YOUR EXHIBITIONS

Pro4events, 3-17 chemin du Lanfonnet – 74320 Sevrier – France  
e-mail [info@pro4events.com](mailto:info@pro4events.com) / [www.cigre-exhibition.com](http://www.cigre-exhibition.com)

**Paris  
Session 2026**



# BUILDING & DISMANTLING TIMES

Paris  
Session 2026



## BUILDING TIMES FOR BASIC (= raw space) :

Thursday 20 August : from **2 pm** to **6 pm**  
Friday 21 August : from **8 am** to **8 pm**  
Saturday 22 August : from 8 am to **midnight**  
Sunday 23 August : from 8 am to **9 am**

## BUILDING TIMES FOR SHELL (= Formule plus) and PREMIUM stands :

Saturday 22 August : from 8 am to **midnight**  
Sunday 23 August : from 8 am to **9 am**

**Stands must be ready on Sunday 23 August at 9:00 am**

For the general cleaning

**The exhibition opens at 12:00 pm (noon)**

## DISMANTLING TIMES

Friday 28 August : from **5 pm** to **midnight**

Disassembly will not be permitted before this time.  
Please inform your builders accordingly.

Saturday 29 August : from **8 am** to **12 pm** (noon)

No badge is required during the building and dismantling times  
(when the exhibition is closed)

For any request and building times, please contact [Marion.caumont@pro4events.com](mailto:Marion.caumont@pro4events.com)

Paris  
Session 2026



# TRANSPORT – CUSTOMS – LOADING & UNLOADING



THE OFFICIAL TRANSPORT COMPANY IS DB SCHENKER [www.dbschenker.com/fr](http://www.dbschenker.com/fr)

Contact : Meriam SAGET : [meriam.saget@dsv.com](mailto:meriam.saget@dsv.com); [foires.expositions@dbschenker.com](mailto:foires.expositions@dbschenker.com)

**Telephone number: +33 (0)1 48 63 31 82**

Reminder : It is prohibited to deposit boxes or stock cases, wood, straw, cardboard, etc... in the Exhibition halls, on the stands or in the aisles.

Emergency equipment must remain visible at all times.

Exhibitors can be invoiced by VIPARIS for waste removal > Viparis store <https://www.viparisstore.com/en/cigre-2026>

Paris  
Session 2026



# DELIVERY OF GOODS

## LOGIPASS platform BY VIPARIS

It is mandatory to register ALL vehicles on line



We remind you that registration of vehicles online is MANDATORY prior to the delivery OR to pick up your goods after dismantling via the LOGIPASS platform of the venue : <https://logipass.viparis.com/en/>  
Hotline +33 (0)1 40 68 11 30 / [infos-exposants@viparis.com](mailto:infos-exposants@viparis.com)



Access to the delivery area  
54 boulevard Gouvion-Saint-Cyr  
75017 Paris  
LEVEL -2

Maximum height : 4,20 m  
Width of access ramps : 3,50 m  
Gradient : 15%

No parking is allowed in the delivery area

Non contractual document  
subject to changes at any time

## SMALL PARCELS

we advise you to send small parcels to your hotel to make sure to get them on time

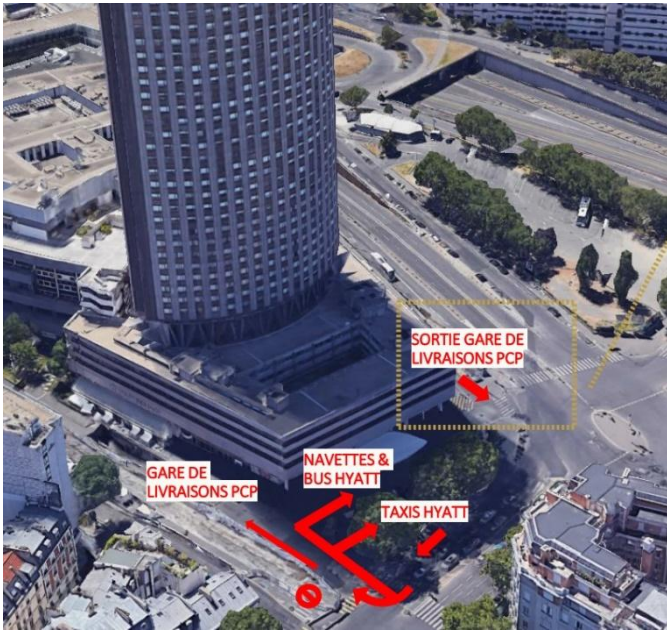

Parking time for heavy trucks limited to 4 hours maximum

For utilities, limited to 2 hours maximum

**ACCESS FOR DELIVERY ONLY**

**NO OVERNIGHT PARKING**

**FOR ALL YOUR DELIVERIES**

> contact DB SCHENKER [www.dbschenker.com/fr](http://www.dbschenker.com/fr)

**Paris  
Session 2026**



The goods lifts operate **ONLY** during building-up and dismantling times

**Access to Level 1 with lifts 6 & 8 > on Sunday 23 August, open ONLY until 9:00 AM**

### BUILDING TIMES FOR BASIC (= raw space)

Thursday 20 August : from 2 pm to 6 pm  
 Friday 21 August : from 8 am to 8 pm  
 Saturday 22 August : from 8 am to midnight  
 Sunday 23 August : from 8 am to 9 am

### BUILDING TIMES FOR SHELL ( Formule plus) and PREMIUM stands :

Saturday 22 August : from 8 am to midnight  
 Sunday 23 August : from 8 am to 9 am

### DISMANTLING TIMES

Friday 28 August : from 5 pm to midnight  
 Saturday 29 August : from 8 am to 12 pm (noon)

**USE ONLY LIFTS MC6 & MC7 and MC8 & MC9**  
**MC1 will also be available**

#### MC6 & MC7

Load : 4 tons  
 Height : 2,08 m  
 Depth : 2,90 m  
 Width : 2,15 m

#### MC8 & MC9

Load : 11 tons  
 Height : 2,20 m  
 Depth : 6,80 m  
 Width : 2,60 m

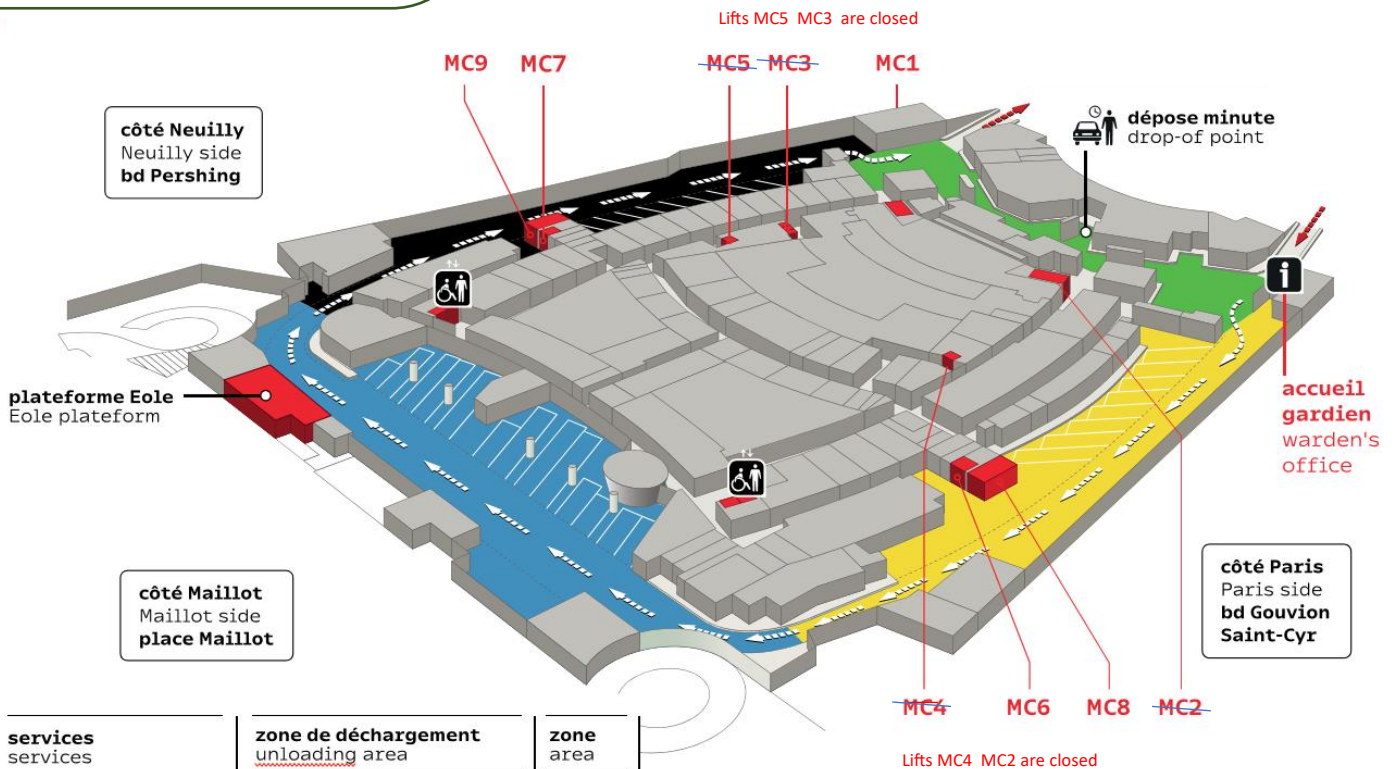

Non contractual document - subject to changes at any time

## FOR YOUR COMMUNICATION

included in your package

Paris  
Session 2026



**EXHIBITORS' PROFILE to register on line**

**As soon as possible MANDATORY**

### Publish information on your company

**OPEN TO EXHIBITORS & CO-EXHIBITORS** > Please, inform your co-exhibitor & copy to [info@pro4events.com](mailto:info@pro4events.com)

Name of company, Address, General mail address, Fields of activity, General activity & products of your company  
no extra cost

**in the GUIDE BOOK** (= 9000 catalogues distributed during the event)  
**+ on the MOBILE APP** (+11000 app downloads last Session)

**> Complete the form on line as soon as possible**

[www.cigre-exhibition.com/exhibitors/exhibitors-guide/guidebook-registration/](http://www.cigre-exhibition.com/exhibitors/exhibitors-guide/guidebook-registration/)

## MEDIA KIT

included in your package

**Download the CIGRE ADVERTISING BANNER for your clients, visitors > [CLICK HERE](#)**

You are invited to insert the banner in your mails or website...

We remind you that visitors need to register online to access the Technical Exhibition (opening from 12 pm (noon) on Sunday 23 August).  
Visitors are also invited to attend the Opening Ceremony on Sunday at 3:30 pm & the welcome cocktail afterwards, until 7:00 pm.

Visitor's badge are FREE with access the Technical Exhibition ONLY



Each badge is valid during all the event from Sunday (noon) to Friday

## FOR YOUR COMMUNICATION

PACK SERVICES included in your package

### PACK SERVICES included in your package

#### Press releases for journalists

A press room is organized for the journalists attending the Session, open to exhibitors wishing to leave Press kits, Press releases or any Press materials (usb keys,..) dedicated to journalists.  
If you know a journalist interested in participating at CIGRE 2026, a press accreditation is required.

**Sales presentations, Business meetings** > Book a small Working room (limited to 1 hour) +/- or a small Meeting room (limited to 1 hour) during the event equipped with a monitor 46" and HDMI connection > Register a slot before the event (first come, first served) > [CLICK HERE](#)

#### Job offers

A Job Center is organized for all the attendees during the Session. Exhibitors are invited to send us their job offers to be posted on a wall > [CLICK HERE](#)

CONTACT : [sandrine.huchez@pro4events.com](mailto:sandrine.huchez@pro4events.com)

#### Networking :

##### Access to the Opening Ceremony

The Opening Ceremony is on Sunday 23 August, 2026, starting at 3:30 pm

Location : Grand Amphi – Access LEVEL 2

Exhibitors, professional visitors & clients are invited to attend the Opening Ceremony.

**WELCOME DRINKS** : Just after the Opening Ceremony, Welcome drinks will be held on the 3 levels

### ON SITE > GO TO THE EXHIBITORS' OFFICE

Rooms 304 /305 Paris side, open from Sunday 23 August, 9 am

Office for Exhibitors + Press center + keys for the allocated meeting rooms for exhibitors (pack services)

Information & Registration for the next Sessions: CIGRE CANADA 2026 & 2027, CIGRE 2027 International Symposium in THAILAND, CIGRE PARIS Level 3 – Room 301 (from Monday to Friday).

contact > [sandrine.huchez@pro4events.com](mailto:sandrine.huchez@pro4events.com)



Non contractual picture

JOB CENTER

[CLICK HERE TO REGISTER](#)

First come, First served

## SERVICES TO ORDER for the stand

Deadline 15 May, 2026

Choose the “Ready to Exhibit” Package  
managed by Pro4events

**ELECTRICITY** (mandatory) + **FURNITURE** + **TV LED SCREEN** (if needed)

> **CHOOSE TO HAVE ONLY 1 SUPPLIER = 1 INVOICE, ALL IN ONE !**

> **CUSTOMIZED SERVICE**

Pro4events team takes care of your orders, replies to your technical questions,  
and gives you feedback

contact > [marion.caumont@pro4events.com](mailto:marion.caumont@pro4events.com) / [brian.rossa@pro4events.com](mailto:brian.rossa@pro4events.com)

Example of a “Ready to Exhibit” Package for a 9 sqm SHELL (formule +), PREMIUM stand  
or a Corner Stand :

**ELECTRICITY** (mandatory to order)

> Example : 3KW = 466 euros (limited period power supply)

+

IN OPTION :

**FURNITURE** > choose from the [CATALOGUE ON LINE HERE](#)

> Example : 1 table (price from 96 euros) + 2 chairs (price from 30 x 2 euros) + 1 corbeille (bin) for  
8 euros + 1 display unit for brochures (price from 104 euros)...

IN OPTION :

**TV LED SCREEN** (price from 318 euros...)

Paris  
Session 2026



With the “Ready to Exhibit” package, Pro4events is taking care of your orders &  
sends you only 1 invoice for ALL the services.

[CLICK HERE TO DOWNLOAD THE ORDER FORM](#)

Send it to [marion.caumont@pro4events.com](mailto:marion.caumont@pro4events.com) / [brian.rossa@pro4events.com](mailto:brian.rossa@pro4events.com) /  
[info@pro4events.com](mailto:info@pro4events.com)

# ELECTRICITY (power supply)

(it is mandatory to order power supply for the stand)

1/ Evaluate the power needed for the stand >>



Average power, subject to changes	
➤	Coffee machine : 1,3 kw – 2 kw
➤	Fridge : 0,2 kw
➤	Kettle = 1kw
➤	Microwaves = 1kw
➤	Laptop = 0,1kw
➤	Screen : 0,2 kw
➤	Computer = 0,5kw
➤	Printer/copy machine = 2,5kw
➤	3 led spots = 1kw

2/ Choose to ORDER Power supply with the “READY TO EXHIBIT” Package  
 = customized service managed by Pro4events ORDER FORM > [CLICK HERE](#)  
 or with the venue on Viparis store > <https://www.viparisstore.com/en/#>

3/ Note the reference & description to complete the ORDER FORM at the end of this document > send it to  
[info@pro4events.com](mailto:info@pro4events.com) / [marion.caumont@pro4events.com](mailto:marion.caumont@pro4events.com) / [brian.rossa@pro4events.com](mailto:brian.rossa@pro4events.com)

4/ Complete the STAND PLAN [CLICK HERE](#)

## PRICES

### LIMITED PERIOD OF POWER SUPPLY – No power during the night

Generated from renewable sources

Reference	Description	Price in € excl. VAT
09003	Limited Period Power Supply - 3kW/13A	466
09004	Limited Period Power Supply - 4kW/16A	720
09006	Limited Period Power Supply - 6kW/8A	893
09008	Limited Period Power Supply - 8kW/20A	1009
10010	Intermittent electrical supply - 10kW/25A	1120
10012	Limited Period Power Supply - 12kW/26A	1152
10020	Limited Period Power Supply - 20kW/32A	1453
10030	Limited Period Power Supply - 30kW/50A - 240/400V	1597
10040	Limited Period Power Supply - 40kW/63A - 240/400V	1756

This option includes:

- Installation and removal of your electrical box
- Energy use during the power supply schedule
- Technical support throughout the event
- In limited period mode, the power will be shut off during the night, according to the schedule established by the event organiser.
- If the limited period power supply level you ordered (or that your event's organiser supplied) is insufficient, this option will allow you to increase it.

Please note, orders placed from 20 August 2026 will be increased by 20%

Prices are in Euros and fixed for the duration of the event - VAT excluded (for French companies only)

Need of more power > contact : [info@pro4events.com](mailto:info@pro4events.com) / [marion.caumont@pro4events.com](mailto:marion.caumont@pro4events.com) / [brian.rossa@pro4events.com](mailto:brian.rossa@pro4events.com)

## 24h/24 POWER SUPPLY

Reference	Description	Price in € excl. taxes
11003	24h/24 Period power supply - 3kW/13A	610
11004	24h/24 Period power supply - 4kW/16A	944
11006	24h/24 Period power supply - 6kW/8A	1161
12008	24h/24 Period power supply - 8kW/12A	1311
12010	24h/24 Period power supply - 10kW/16A	1456
12012	24h/24 Period power supply - 12kW/20A	1498
12020	24h/24 Period Power Supply - 20kW/32A	1887
12030	24h/24 Period Power Supply - 30kW/50A - 240/400V	2075
12040	24h/24 Period Power Supply - 40kW/63A - 240/400V	2283

This option includes:

- Installation and removal of your electrical box
- Energy use during the power supply schedule
- Technical support throughout the event
- In 24h/24 mode, the power remains on 24/7, according to the dates and times chosen by the organiser of the event.

**COMPLETE THE TECHNICAL PLAN**  
[CLICK HERE](#)

Please note, orders placed from 20 August 2026 will be increased by 20%

Prices are in Euros and fixed for the duration of the event - VAT excluded (for French companies only)

Need of more power > contact : [marion.caumont@pro4events.com](mailto:marion.caumont@pro4events.com) / [brian.rossa@pro4events.com](mailto:brian.rossa@pro4events.com) / [info@pro4events.com](mailto:info@pro4events.com)

Orders cannot be changed after 30 June, 2026 - Any cancellation of the electrical boxes on site will be invoiced.

Do not forget to leave an access to the electrical panel during all the event



PICTURES ARE NON CONTRACTUAL

**VIPARIS will install the Electrical box on the stand**  
**Exhibitors cannot choose the type of electrical box**



Electrical box KELIPSE up to 6kw  
91 x 29 cm with 2 sockets

Electrical box up to 8kw  
44 x 25 x 21 cm with 3 sockets



Electrical box up to 20 kw  
44,5 x 25 x 21,5 with 3 sockets



Electrical box up to 20 kw  
40 x 37,5,5 with 3 sockets



Electrical box 30 kw (50A) 40 kw (63A)

Power is supplied by Viparis as a 50 hertz 3-phase current with an average voltage of 400 volts phase-to-phase or 230 volts phase-to-neutral. Current is distributed by a power cable ending in a sealed terminal box fitted with a circuit breaker and 30 mA differential switch (for safety).

Repositioning of a box after installation will be invoiced to the Exhibitor

## FURNITURE / TV SCREEN

1/ choose to order **FURNITURE + a TV SCREEN** *if needed* with the “**READY TO EXHIBIT**” Package  
= customized service managed by Pro4events > Electricity + Furniture + TV screen, All in one > [CLICK HERE](#)

or order Furniture with Camerus (excluded screens) > <https://camerus.com/en/showroom/cigre-2026/>

2/ Note the reference & description to complete the [ORDER FORM](#) > send it [marion.caumont@pro4events.com](mailto:marion.caumont@pro4events.com) / [brian.rossa@pro4events.com](mailto:brian.rossa@pro4events.com) / [info@pro4events.com](mailto:info@pro4events.com)

TABLES, CHAIRS, STORAGE, DISPLAY UNITS, COFFEE MACHINES, FRIDGE.....

+

TV LCD SCREEN

Description	Price in € excl VAT
LED 32" Full HD	318
LED 43" UHD	434
LED 49/50" UHD	530
LED 55" UHD	590
LED 75" UHD	975



Non contractual pictures

ALL TV's are provided with a stand and an HDMI cable (there is no offer for TV's mounted on a wall)

Prices are in Euros and fixed for the duration of the event - VAT excluded

Orders placed after 20 August, 2026 will be increased by 20%

Delivery of furniture & installation of the TV on the stand is included

Paris  
Session 2026



# STORAGE ROOM

## For Formule PLUS stands ONLY in OPTION

Premium stands have already a storage room, included in the package

- 1/ Complete the ORDER FORM [CLICK HERE](#) if you need a storage room for your Formule + (shell) stand
- 2/ Indicate the location of the storage room on the floor plan at the end of this document  
Do not forget to position your stand (aisle, nearby stand...)

Architecture (1) (2)	Price VAT excluded
Storage room 1,00 m x 1,00 m	223 euros
Storage room 1,00 m x 2,00 m with a key to close the room	265 euros

(1) In addition to Formule Plus shell-stand partitions

(2) All prices are including delivery and manpower. All damaged items will be invoiced to the exhibitor.

Please note, orders placed from 20 August 2026 will be increased by 20%  
Prices are in Euros and fixed for the duration of the event - VAT excluded

COMPLETE THE TECHNICAL PLAN  
[CLICK HERE](#)

Paris  
Session 2026



Informations are subject to change at any time  
Pro4events, 3-17 chemin du Lanfonnet – 74320 Sevrier – France  
e-mail [info@pro4events.com](mailto:info@pro4events.com) / [www.cigre-exhibition.com](http://www.cigre-exhibition.com)

# RIGGING STRUCTURES

suspension (hanging) points

ORDER FROM VIPARIS



The Palais des Congrès (VIPARIS) is the **ONLY** company allowed to install slings.

**Maximum weight by hanging point : 5 kg**

Obligation of a point all the 1m – 1m50 according on the signage to hang

**Maximal size for suspended signage : 5 m**

If your signage is longer than 5 m, it necessarily has to have a grip on the ground.

Materials authorized for your structure: Drop, cover, fine PVC (above 4 mm) or wood against plated.

To be validated your request must be necessarily accompanied by a plan with its orientation in the hall or the space + a rise and/or seen in prospect (perspective).

The delivered service includes exclusively the hanging point. The catcher of the structure must be made by the exhibitor or the decorator of the pit.

Any hanging point in the ceilings of the Palais des Congrès de Paris has to be the object of an estimate.

Price for each hanging point should be **130,91 euros** (Excl. VAT) – this price includes only the installation of the hanging point > For more information and quotation, please, contact VIPARIS.

**[CLICK HERE TO SEE THE VIPARIS FORM & PRICE](#)**

CONTACT VIPARIS

> OUNNOUGHENE Moussa ; [moussa.ounnoughene@viparis.com](mailto:moussa.ounnoughene@viparis.com)

Paris  
Session 2026



Informations are subject to change at any time  
Pro4events, 3-17 chemin du Lanfonnet – 74320 Sevrier – France  
e-mail [info@pro4events.com](mailto:info@pro4events.com) / [www.cigre-exhibition.com](http://www.cigre-exhibition.com)



## WIFI

Included in the Exhibitors' package

### WIFI 2.4 Ghz is included in your package

When connecting to our Free Wi-Fi for the first time, users are asked to provide their full name and e-mail address, and to accept the general terms and conditions.

### DSL ORDER on VIPARIS store > <https://www.viparisstore.com/en/#>

Access to DSL connectivity with equal upload and download speeds. Each client has an independent and secure VPN.

Reference	Description	Price in € excl. taxes
51381	VLAN access point - 5 to 7 days	113,87
51317	2 Mbps Ethernet connection	423,87
51455	6 Mbps Ethernet connection	762,17
51413	10 Mbps Ethernet connection	1,460,66
51414	20 Mbps Ethernet connection and more on <a href="https://www.viparisstore.com/en/#">https://www.viparisstore.com/en/#</a>	2,921,32



### CUSTOMIZED WIFI ORDER on VIPARIS store > <https://www.viparisstore.com/en/#>

Wi-Fi\_Expert is available on an account-by-account basis. Organisers and exhibitors can connect to a 5 GHz Wi-Fi network with an 8 Mbps bandwidth. A login and password are required and can be customised upon request.

Reference	Description	Price in € excl. taxes
92400	Wi-Fi Expert 5GHz account	103.48
51452	8 Mbps internet access with 4 simultaneous WiFi connections and one Ethernet connection	669.22
51459	12 Mbps internet access with 8 simultaneous WiFi connections and one Ethernet connection	1046.37
51454	20 Mbps internet access with 20 simultaneous WiFi connections and one Ethernet connection and more on <a href="https://www.viparisstore.com/en/#">https://www.viparisstore.com/en/#</a>	2061.99

Please note, orders placed from 20 August 2026 will be increased by 20%

Prices are in Euros and fixed for the duration of the event - VAT excluded

**MANDATORY** to Indicate the location of the cables & connections,

on the **FLOOR PLAN** [CLICK HERE](#)

# OFFICE EQUIPMENT

## LASER PRINTERS ORDER on VIPARIS store > <https://www.viparisstore.com/en/#>

Reference	Description	Price in € excl. taxes
LNIMP11_VIP	Laser Printer A4 - Black & White	173.00
LNIMP12_VIP	Laser Printer A4 – Color See more items on <a href="https://www.viparisstore.com/en/#">https://www.viparisstore.com/en/#</a>	229.00

## PC & TERMINALS

Reference	Description	Price in € excl. taxes
LNAIO23T_VIP	PC LED 23" TOUCHSCREEN pack / Wifi 5Ghz	277.00
LNPC217_VIP	PC Core i7 / Screen 15" Full HD laptop	379.00
LNPC218_VIP	Samsung Galaxy TAB 10,1"	81.00
LN0002_VIP	OXY 22" Interactive touchscreen kiosk	657.00



Exhibitors are responsible for the equipment. Do not leave it unattended. Exhibitors must be present when it is delivered.

## APPLE PRODUCTS

Reference	Description	Price in € excl. taxes
LNIPAD4_VIP	IPAD Pro 12,9" ®	199.00
LNIPAD3_VIP	IPAD Air 2®	81.00
LNIPAD2_VIP	Floor display for iPad (cannot be rented alone)	57.00
LNMC312_VIP	MacBook TFT 15"	409.00
LNMC114_VIP	iMac LED 24" M3 8core / wifi 5Ghz	376.00

Please note, orders placed from 08/20/2026 will be increased by 20%. Prices are in Euros and fixed for the duration of the event - VAT excluded

## TELEPHONE LINES

Reference	Description	Price in € excl. taxes
61235	VoIP line + hire of VoIP handset + flat rate for calls	379.31

## VIDEO PROJECTORS

Reference	Description	Price in € excl. taxes
87962	HD 5K lumens laser video projector for meeting rooms See more items on <a href="https://www.viparisstore.com/en/#">https://www.viparisstore.com/en/#</a>	340.73/1st day

Please note, orders placed from 20 August 2024 will be increased by 20%. Prices are in Euros and fixed for the duration of the event - VAT excluded

Informations are subject to change at any time

## ELECTRICAL EQUIPMENT

Reference	Description	Price in € excl. taxes
44113_PCP	Multi-socket power strip (3 sockets)	17.44
44121_PCP	Five-metre extension cable	17.44
52544_PCP	Power transformer	380.91
14130_PCP	Female P17 16A three-phase + N + E power socket + 0,50m of 6sq.mm cable	85.91
14179_PCP	Male P17 16A three-phase + N + E power socket + 0,50m of 6sq.mm cable	51.73
14131_PCP	Female P17 32A three-phase + N + E power socket + 0,50m of 6sq.mm cable	91.84
14174_PCP	Male P17 32A three-phase + N + E power socket - Includes 0,50metre cable (6mm <sup>2</sup> ).	56.75
14132_PCP	Female P17 32A three-phase + N + E power socket + 0,50m of 6sq.mm cable	245.63
14175_PCP	Male P17 63A three-phase + N + E power socket + 0,50m of 6sq.mm cable	153.67

Please note, orders placed from 20 August 2026 will be increased by 20%

Prices are in Euros and fixed for the duration of the event - VAT excluded

ORDER with the venue VIPARIS > <https://www.viparisstore.com/en/#>



Paris  
Session 2026



Informations are subject to change at any time

## CLEANING

Included in the exhibitors' package

GENERAL CLEANING is included in your package

+ cleaning of your stand after the building up

+ cleaning of your stand every day

= carpet cleaning and emptied garbage cans

WASTE REMOVAL ORDER on VIPARIS store > <https://www.viparisstore.com/en/#>

Reference	Description	Price in € excl. taxes
83020_PCP	Carpet removal (price per sq.m.)	1.28 / sqm
82981_PCP	Removal of booth material (on filmed wooden palet)	272.70



Please note, orders placed from 20 August 2026 will be increased by 20%

## CATERING

at your stand or in a meeting room

Exhibitors can order catering service at the stand or in a meeting room

(It is not allowed to prepare food at the stand)

**Catering from HYATT REGENCY PARIS ETOILE**

**ORDER FORM [CLICK HERE](#)**

Contact : Marion d'Esparbes Jues > [marion.desparbesjues@hyatt.com](mailto:marion.desparbesjues@hyatt.com)

Tel. : +33 (0)6 58 69 50 89

**For your information, on the exhibition floor :**

**Coffee breaks** OPEN to ALL every day (Sunday 14:00 > 15:30) (Monday > Friday 9:30 – 11:00 / 15:00 – 17:00) Levels 1,2,4

**Lunch bars** (snacks, salads) every day from Monday to Friday Levels 1,2,4

Inside & outside the Congress Center, you can access to restaurants and a supermarket.

Paris  
Session 2026



## HOSTESS

### ORDER FROM DECIBELLES

Contact : Ana Calpe del Arco

e-mail : ana@deci-belles.com - Tel. +33 (0)1 40 60 11 28

HOSTESS : 224 € (8 hours) + 14.5 € MEAL & TRANSPORT

BARMAN : 240 € (8 hours) + 14.5 € MEAL & TRANSPORT

HANDLER : 240 € (8 hours) + 14.5 € MEAL & TRANSPORT

INTERPRETER : 256 € (8 hours) + 14.5 € MEAL & TRANSPORT

Deadline : 03 August 2026

Prices are in Euros and fixed for the duration of the event - VAT excluded

[DOWNLOAD THE ORDER FORM HERE](#)

## SECURITY GUARDS

at your stand

### ORDER FORM HERE

Contact : Cédric Guerin

e-mail : cedric.guerin@guardevents.com - Tel. +33 (0)1 56 08 01 39

12 hours shift = 390,00 €

Additional hours = 49,00 €

Deadline : 30 July 2026

Prices are in Euros and fixed for the duration of the event - VAT excluded

[DOWNLOAD THE ORDER FORM HERE](#)

Paris  
Session 2026



Informations are subject to change at any time

## FLORAL DECORATION - PLANTS

Exotic or tropical plants, dwarf shrubs, arum lilies, citrus fruits, decorative foliage  
bouquets, dried flowers  
Fruit basket, flower arrangements



37.50 €



56,25 €



128,75 €

AND MUCH MORE to see on VIPARIS STORE > <https://www.viparisstore.com/en/#>



Please note, orders placed from 20 August, 2026 will be increased by 20%  
Prices are in Euros and fixed for the duration of the event - VAT excluded

Paris  
Session 2026



# BADGE READER

SCAN the QR code on Delegates, Visitors' badges to get their contact

**Two (2) products are included in your package (no extra charge – provided by LENI company) :**

1/ 1 Klipsoreader > it's a badge reader with the license pre-installed.

2/ 1 Klipsoleads license that can be downloaded to your own **smartphone**.

It is activated with an activation code provided by LENI company: 1 activation code per smartphone.



**The badge reader has to be collected from Saturday, 22 August, from 8 am,**  
at the Exhibitors Technical Services (LENI's desk) on LEVEL 0 (next to the cloakroom),  
**and returned on site at the end of the Congress on Friday 28 August ROOM 104 LEVEL 1.**

You must leave a deposit of 400 € per badge reader – Mandatory  
(bank footprint or French cheque - no Amex - no cash)

**The license can be installed on your smartphone as soon as you get the activation code from LENI company.**

Note that the activation code will not be available before August 22, 2026. **Contact : [lecteurs@leni.fr](mailto:lecteurs@leni.fr)**

**If you want to order more license :** 1 more license = **320 euros** (VAT excl.) > contact:  
[marion.caumont@pro4events.com](mailto:marion.caumont@pro4events.com) / [brian.rossa@pro4events.com](mailto:brian.rossa@pro4events.com)

The Excel file of the contacts scanned during the Congress will be available on your badge reader area via your exhibitor space on your platform on line (after the Congress).

Technical information from LENI company on

> <https://www.cigre-exhibition.com/wp-content/uploads/sites/1/Klipso-leads-DECK-EN-200422.pdf> [cigre-exhibition.com]

Paris  
Session 2026



Informations are subject to change at any time  
Pro4events, 3-17 chemin du Lanfonnet – 74320 Sevrier – France  
e-mail [info@pro4events.com](mailto:info@pro4events.com) / [www.cigre-exhibition.com](http://www.cigre-exhibition.com)

# TECHNICAL ASSISTANCE

## on site

### ON SITE TECHNICAL SERVICES FOR EXHIBITORS

Welcome desk to assist Exhibitors with power on stand, delivery of furniture, shell stands, premium stands, delivery & handling by ESI, catering ... pick up of your badge reader with LENI...

#### LOCATION :

LEVEL 0 (next to the cloakroom) from Thursday 20 to Monday 24

LEVEL 1 (room 104) from Tuesday 25 to Friday 28

#### Exhibitors Technical services opening hours :

Thursday 20 August	8 am - 6 pm
Friday 21 August	8 am - 8 pm
Saturday 22 August	8 am - 8 pm
Sunday 23 August	8 am - 8 pm
Monday 24 August	8 am - 6 pm
Tuesday 25 August	8 am - 6 pm
Wednesday 26 August	8 am - 6 pm
Thursday 27 August	8 am - 6 pm
Friday 28 August	8 am - 5 pm

Orders have to be sent to Pro4events before the event > Deadline 15 May 2026.

If any questions, please send a mail to [info@pro4events.com](mailto:info@pro4events.com) / [marion.caumont@pro4events.com](mailto:marion.caumont@pro4events.com)

Paris  
Session 2026



Informations are subject to change at any time  
Pro4events, 3-17 chemin du Lanfonnet – 74320 Sevrier – France  
e-mail [info@pro4events.com](mailto:info@pro4events.com) / [www.cigre-exhibition.com](http://www.cigre-exhibition.com)

# GENERAL SECURITY

**Security** : From SUNDAY 23 August to FRIDAY 28 August, each attendee will be checked by SECURITY at level 0 (street level)

## EXPECT LONGER DELAYS TO ACCESS THE SESSION

To ensure security during your stay at the Palais des Congrès in Paris, we have increased the number of agents during the Session, in addition to webcams.

Recommendations :

- . Avoid bringing suitcases to the Session: we have reduced the size of storage,
- . Remember to collect your items at the cloakroom on the same day during opening hours,
- . Security agents will apply the access control policy, kindly follow their instructions,
- . Report all suspicious objects or behaviour to security agents or to the police,
- . Do not accept to keep any item for someone else,
- . Do not allow items to pile up (cardboard boxes, pallets, bags etc.),
- . In case of emergency – call the police on **17** (or 197).

*Security is a collective responsibility. We thank you in advance for your help and understanding.*

**Safety measures:** Health and safety are our TOP priority. The venue, VIPARIS, has been accredited with the label « **Safe V Events** » from an independent authority.

All the necessary health measures are taken to ensure the highest standards during the Session : **Disinfection** of rooms, common areas, surfaces, equipment, lifts at all times, hand sanitiser available, air recycling, **Medical Center** with dedicated medical staff on level 3 (room 335).

**Environment** : with our partners, we aim at reducing our environmental footprint and sharing best practices.

### RECYCLING CENTER for Waste Reduction on LEVEL 0

Drop your badges, lanyards, papers for recycling once you have finished your visit at the Conference & exhibition.  
Drop your bags to be reused for future events.

Note that it is required to wear your personal badge during all the time of your visit, as many days as necessary. Don't drop it before ! your badge will not be re-printed.

Paris  
Session 2026



Informations are subject to change at any time  
Pro4events, 3-17 chemin du Lanfonnet – 74320 Sevrier – France  
e-mail [info@pro4events.com](mailto:info@pro4events.com) / [www.cigre-exhibition.com](http://www.cigre-exhibition.com)

## INSURANCE

Badge readers, mobile phones, computers left unattended are not covered by the insurance.

**>> Please do not to leave any valuable overnight, even in a locked storage room or in a locked cabinet.**

**[CLICK HERE](#)** to get more information about guarantees & exclusions

## VAT REFUND

**TEVEA INTERNATIONAL** 29-31 rue Saint Augustin F 75002 PARIS, France  
[www.tevea-international.com](http://www.tevea-international.com)

[mail@tevea.fr](mailto:mail@tevea.fr)

**[CLICK HERE](#)** to get more information

Paris  
Session 2026



Informations are subject to change at any time  
Pro4events, 3-17 chemin du Lanfonnet – 74320 Sevrier – France  
e-mail [info@pro4events.com](mailto:info@pro4events.com) / [www.cigre-exhibition.com](http://www.cigre-exhibition.com)

## RECYCLING – REUSE CENTER

### For Waste reduction

As part of CIGRE's sustainability initiatives, a Recycling Center will be available during the Congress.

On the very last day of your visit, you may want to drop your papers, badges, lanyards in the recycling box on level 0. \*

Participation in this initiative is entirely optional and contributes to CIGRE's commitment to environmental responsibility.

\*your badge will be printed only 1 time for the duration of your visit. Please, keep it with you all along your stay.

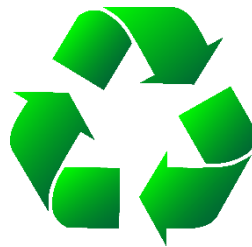

Paris  
Session 2026



Informations are subject to change at any time

Pro4events, 3-17 chemin du Lanfonnet – 74320 Sevrier – France  
e-mail [info@pro4events.com](mailto:info@pro4events.com) / [www.cigre-exhibition.com](http://www.cigre-exhibition.com)

# TO ATTEND CONFERENCES

not included with the Exhibitors' badge

[www.cigre.org](http://www.cigre.org)

REGISTER HERE TO ATTEND CONFERENCES > <https://registrations.cigre.org/>

Early bird : register before 31 May, 2026

General programme CIGRE 2026 [CLICK HERE](#)



Over 160 working meetings,  
30 Study Committee sessions  
and around 1000 technical papers  
focus on and discuss the association's  
16 fields of activities.

PHOTO GALLERY > [click here](#)

VIDEO > [click here](#)

Non contractual picture

+ 11 200 attendees  
from 120 countries  
including 4 500 Conference Attendees  
Statistics 2024



POSTERS

#### Scopes of 16 Study Committees

- Rotating Electrical Machines
- Power transformers and reactors
- Transmission & distribution equipment
- Insulated Cables
- Overhead lines
- Substations and electrical installations
- DC systems and power electronics
- Protection and Automation
- Power system development and economics
- Power system operation and control
- Power system environmental performance
- Power system technical performance
- Electricity markets and regulation
- Active distribution systems and Distributed energy resources
- Materials and emerging test techniques
- Information systems and telecommunication

Just before & during the Session find the  
updated informations on the mobile App

Paris  
Session 2026

